

JVC

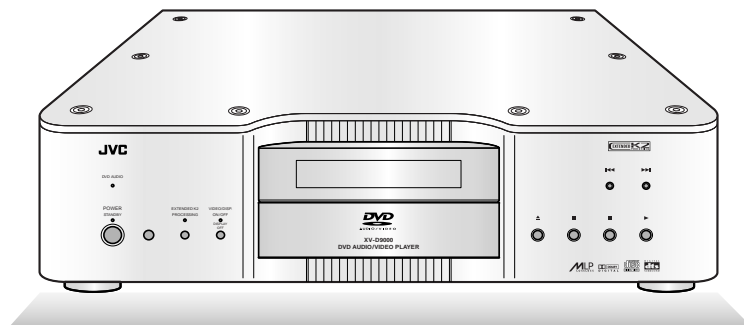

DVD AUDIO/VIDEO PLAYER

XV-D9000



INSTRUCTIONS

For Customer Use:

Enter below the Model No. and Serial No. which are located either on the rear, bottom or side of the cabinet. Retain this information for future reference.

Model No. _____

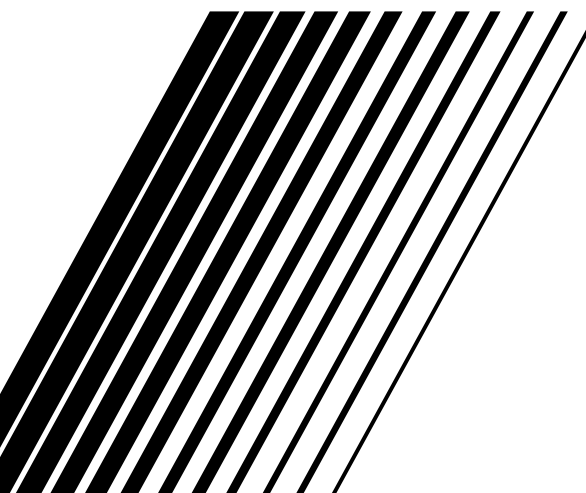

Serial No. _____

LVT0454-002A
[J]



Warnings, Cautions and Others

(For U.S.A)

	CAUTION RISK OF ELECTRIC SHOCK	
CAUTION: TO REDUCE THE RISK OF ELECTRIC SHOCK DO NOT REMOVE COVER (OR BACK) NO USER SERVICEABLE PARTS INSIDE REFER SERVICING TO QUALIFIED SERVICE PERSONNEL.		



The lightning flash with arrowhead symbol, within an equilateral triangle is intended to alert the user to the presence of uninsulated "dangerous voltage" within the product's enclosure that may be of sufficient magnitude to constitute a risk of electric shock to persons.



The exclamation point within an equilateral triangle is intended to alert the user to the presence of important operating and maintenance (servicing) instructions in the literature accompanying the appliance.

WARNING: TO REDUCE THE RISK OF FIRE OR ELECTRIC SHOCK, DO NOT EXPOSE THIS APPLIANCE TO RAIN OR MOISTURE.

INFORMATION

This equipment has been tested and found to comply with the limits for a Class B digital device, pursuant to Part 15 of the FCC Rules. These limits are designed to provide reasonable protection against harmful interference in a residential installation. This equipment generates, uses, and can radiate radio frequency energy and, if not installed and used in accordance with the instructions, may cause harmful interference to radio communications. However, there is no guarantee that interference will not occur in a particular installation. If this equipment does cause harmful interference to radio or television reception, which can be determined by turning the equipment off and on, the user is encouraged to try to correct the interference by one or more of the following measures:

- Reorient or relocate the receiving antenna.
- Increase the separation between the equipment and receiver.
- Connect the equipment into an outlet on a circuit different from that to which the receiver is connected.
- Consult the dealer or an experienced radio/TV technician for help.

For Canada/pour le Canada

CAUTION: TO PREVENT ELECTRIC SHOCK, MATCH WIDE BLADE OF PLUG TO WIDE SLOT, FULLY INSERT.

PRECAUTION: POUR EVITER LES CHOCS ELECTRIQUES, INTRODUIRE LA LAME LA PLUS LARGE DE LA FICHE DANS LA BORNE CORRESPONDANTE DE LA PRISE ET POUSSER JUSQU'AU FOND.

For Canada/pour le Canada

THIS DIGITAL APPARATUS DOES NOT EXCEED THE CLASS B LIMITS FOR RADIO NOISE EMISSIONS FROM DIGITAL APPARATUS AS SET OUT IN THE INTERFERENCE-CAUSING EQUIPMENT STANDARD ENTITLED "DIGITAL APPARATUS," ICES-003 OF THE DEPARTMENT OF COMMUNICATIONS.

CET APPAREIL NUMERIQUE RESPECTE LES LIMITES DE BRUITS RADIOELECTRIQUES APPLICABLES AUX APPAREILS NUMERIQUES DE CLASSE B PRESCRITES DANS LA NORME SUR LE MATERIEL BROUILLEUR: "APPAREILS NUMERIQUES", NMB-003 EDICTEE PAR LE MINISTRE DES COMMUNICATIONS.

1. CLASS 1 LASER PRODUCT
2. **DANGER:** Invisible laser radiation when open and interlock failed or defeated. Avoid direct exposure to beam.
3. **CAUTION:** Do not open the top cover. There are no user serviceable parts inside the unit; leave all servicing to qualified service personnel.

1. PRODUIT LASER CLASSE 1
2. **ATTENTION:** Radiation laser invisible quand l'appareil est ouvert ou que le verrouillage est en panne ou désactivé. Eviter une exposition directe au rayon.
3. **ATTENTION:** Ne pas ouvrir le couvercle du dessus. Il n'y a aucune pièce utilisable à l'intérieur. Laisser à un personnel qualifié le soin de réparer votre appareil.

CAUTION

To reduce the risk of electrical shocks, fire, etc.:

1. Do not remove screws, covers or cabinet.
2. Do not expose this appliance to rain or moisture.

ATTENTION

Afin d'éviter tout risque d'électrocution, d'incendie, etc.:

1. Ne pas enlever les vis ni les panneaux et ne pas ouvrir le coffret de l'appareil.
2. Ne pas exposer l'appareil à la pluie ni à l'humidité.

Caution — POWER switch!

Disconnect the power plug to shut the power off completely. The POWER switch in any position does not disconnect the power source. The power can be remote controlled.

Attention — Commutateur POWER!

Déconnecter la fiche de secteur pour couper complètement le courant. Le commutateur POWER ne coupe jamais complètement la ligne de secteur, quelle que soit sa position. Le courant peut être télécommandé.

Contents

Warnings, Cautions and Others	2	fs/RATE Display [fs/RATE]	39
Features	5	Changing the Progressive Mode	41
Usage Precautions	6	Enjoying DVD Audio	42
Connections	7	Using the menu to select an item to play	42
Precautions to Observe When Setting Up the Connections	7	Selecting a Track	43
Connecting to a TV with a DVD Component Video		Selecting an Index Item	44
Input Terminal	8	Still image display operations	44
Connecting to a TV	9	Advancing/replaying still images [PAGE +/-]	44
Connecting to an Amplifier or Receiver	10	Jumping to specified still images on a disc [RETURN]	44
Connecting to an Amplifier with a 5.1 Channel Input Terminal ..	11	Program Playback	45
Connecting to a Device with a Digital Input Terminal	12	Random Playback	46
Connecting to the Power Supply	13	Repeat Playback	46
Preparing the Remote Control	14	A-B Repeat Playback	47
Parts and Their Functions	15	Changing the Angle [ANGLE]	47
Front Panel	15	Changing the Subtitles [SUBTITLE]	48
Display Section	16	Changing the Audio Setting [AUDIO]	49
Rear Panel	17	Playing a Bonus Group	49
Remote Control	18	Playing DVD Video Discs	51
Before You Start	20	Selecting the Section You Want to Watch	51
Opening Screen	20	Using the menu to select an item to play	51
Preventing Screen Burn-in [Screen Saver]	20	Specifying the title number to begin playback	52
On-screen guide icons	20	Specifying the chapter number to begin playback	
Types of Disc Supported by this Player	21	(Chapter search)	52
Disc Composition	22	Repeat Playback	52
Switching the Power On	23	A-B Repeat Playback	53
Initial Settings	24	Changing the Angle [ANGLE]	53
Setting Up the Initial Settings	24	Changing the Subtitles [SUBTITLE]	54
PREFERENCE 1 Settings	25	Changing the Audio Language [AUDIO]	54
PREFERENCE 2 Settings	27	Parental Lock Setting	55
SPK. SETTING Screen Settings	29	Setting Parental Lock	55
Basic Operations	32	Changing Parental Lock	56
Loading a Disc	32	Temporarily Cancelling Parental Lock	57
Playing a Disc	33	Playing Audio CD and Video CD Discs	58
Step-by-Step Procedure for Playing a Disc	33	Selecting a Song from a Menu	59
Stopping a Disc	33	Selecting a Track	59
Pausing a Disc	33	Selecting an Index Item	59
Skipping Through a Disc	33	Program Playback	60
Fast Forward/Backward Through a Disc	34	Random Playback	61
Resume Playback [RESUME]	34	Repeat Playback	61
Storing the resume position	34	A-B Repeat Playback	62
Resuming Playback	34	Changing the Audio Channel [AUDIO]	62
Viewing One Frame at a Time	35	Extended K2 Processing Version 2.0 Function	63
Slow Motion Playback	35	Handling Discs	64
Playing Time Display [TIME DISPLAY]	36	Troubleshooting	65
Using time display during playback	36	Specifications	66
Using time display while a disc is stopped		Dimensions	67
(using [TIME DISPLAY])	36	Table of Languages and Their Abbreviations	68
Using time display while a disc is stopped	37	Country Code List for Parental Lock	69
Turning the Display Off to Get Better Sound Quality		Glossary	70
[DISPLAY OFF]	38		
Adjusting the Image Brightness [THEATER POSITION]	39		

Features

High-end DVD player for playback of Audio DVDs and Video DVDs. The machine makes full use of the latest advances in DVD technology.

Extended K2 Processing Version 2.0

Extended K2 processing takes the music signal before any band limitation is presumed and the digital signal is expanded for the high bit and high sampling. Version 2.0 strengthens this frequency by as much as four times and is carried by the front two channels. 44.1 kHz and 48 kHz are expanded and reformed as 24 bit 176.4 kHz and 192 kHz signals respectively. This means that the playback quality of the digital source is one level closer to the original master.

PEM • DD Converter with 192 kHz/24 bit Support

This model includes our recently developed PEM • DD converter that supports the 192 kHz/24 bit signal that is top specification for Audio DVD voice format. The front two channels use separate DAC configurations for the left and right channels. With a dynamic range of 112 dB, it achieves a high frequency distortion factor of less than 0.001 %. In addition, all channels use the same D/A converter which provides a jitter-free fine clock generator and the use of dedicated audio R core power transformer and other features deliver excellent sound quality.

Interference-free, Vibration-free, Resonance-free Construction

Each circuit is isolated to exclude mutual interference between the circuits, with each five block structure being independent. Analog related circuits are completely isolated from the sub-chassis with the digital elements such as the dedicated audio power transformer. Furthermore, the occurrence of unnecessary oscillation and outside influences are excluded by the 3.2 mm steel base plate and the solid aluminum casing. The airtightness of the unit has been dramatically improved with the use of an airtight disc tray to shut out external vibration and option of completely turning off the video circuitry to achieve the maximum sound quality possible.

Progressive Video Output

The progressive output (525P) of the video signal from a 24-frame/second film reduces flicker so that it is not noticeable, even when played back on a large screen, for sharp, clear images. This matches the reality and enjoyment achieved in movie theaters. Moreover, our recently developed three dimensional progressive function means that normal video can also achieve the same quality as DVD titles and film through this progressive conversion to digital images.

Usage Precautions

Installing the player

Install the player in a location where the temperature is between 5 °C to 35 °C (41 °F to 95 °F). If the player is exposed to a higher temperature, it may cause it to malfunction, or cause damage. In particular, avoid installing it in the following locations.

- Locations where it is exposed to direct sunlight
- Locations that become hot, such as on top of a receiver

If TV or radio reception deteriorates...

- Keep distance between the TV or radio and this player. If this player is installed near equipment that receives electromagnetic waves, it may effect reception.

Moving the Player

- If you move the player from a cold location to a warm location, do not use the player immediately after moving it. This is because condensation can form inside the player. If you allow the player to stand with the power on for a few hours, you can then use it normally.
- Always remove discs from the player before moving it. If you move the player while a disc is inside, the disc can become lodged inside the player and will be difficult to remove, and can also cause damage.

Do not insert warped or irregular shaped discs

- Do not insert cracked or warped discs into the player, or discs that have been repaired with adhesive, or heart-shaped discs, octagonal discs, or other irregular shaped discs. These can cause damage.

Cleaning the exterior of the player

- To clean the cover and other exterior parts of the player, wipe them with soft, dry cloth. For persistent stains or dirt, wipe them with a cloth moistened with a mild detergent. Never use thinner, benzine, or other inflammable agents. This can cause cloudiness or discoloring of the exterior.

Trademark and Copyright Information

- This player is based on technology licensed from Dolby Laboratories Inc. Dolby, Pro Logic, MLP Lossless, and the Dolby D logo  are trademarks of Dolby Laboratories Inc. (Confidential copyright.) © 1992-1998 Dolby Laboratories Inc. All rights reserved.
- This player is based on technology licensed from Digital Theater Systems Inc. DTS and DTS Digital Surround are trademarks of Digital Theater Systems Inc. ©1996 Digital Theater Systems, Inc. All Right Reserved.
- This player uses copy protection technology. This copy protection technology is licensed by Macrovision Inc. for use in the United States and other countries. To use this technology a license is required from Macrovision Inc. Without a license form Macrovision Inc., you may not use this technology outside the limited range of home use. The disassembly or reverse engineering of this technology is also prohibited.
- The unauthorized copying, broadcast, presentation, and rental of DVD discs, without the permission of the copyright owner is prohibited.
- The DVD logo is a registered trademark.

Connections

- The sound quality can be subtly effected depending on the material and construction of the connection cables and cords. Connection cables or cords are not supplied with this player. These must be purchased separately. We recommend that you compare several types and choose cables/cords best suited to your needs.

In order to use this model, it must be connected to a TV or monitor.

- * To avoid repetition of the various procedures, the following descriptions explain the procedures assuming a connection to a TV. However, you can also connect the player to a monitor or projector instead of a TV.

Precautions to Observe When Setting Up the Connections

- Before connecting any cables, make sure that power to player itself and the other devices is switched off.
- Depending on the device used, the labels for the terminals may differ. Refer to the manual provided with your device when making connections.
- Make sure you insert all plugs firmly. A loose connection can cause noise or the loss of sound.
- Connect the video output from the player directly to a TV (or monitor). If the video output is connected via a video player, the picture quality during playback will deteriorate.

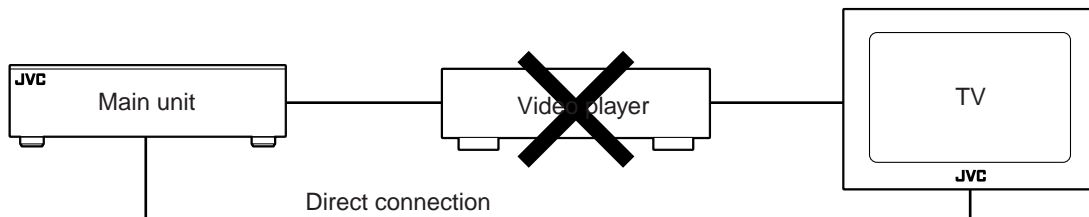

Connecting to a TV with a DVD Component Video Input Terminal

By using the component video output terminal to connect the player to the TV you can enjoy high-quality video performance.

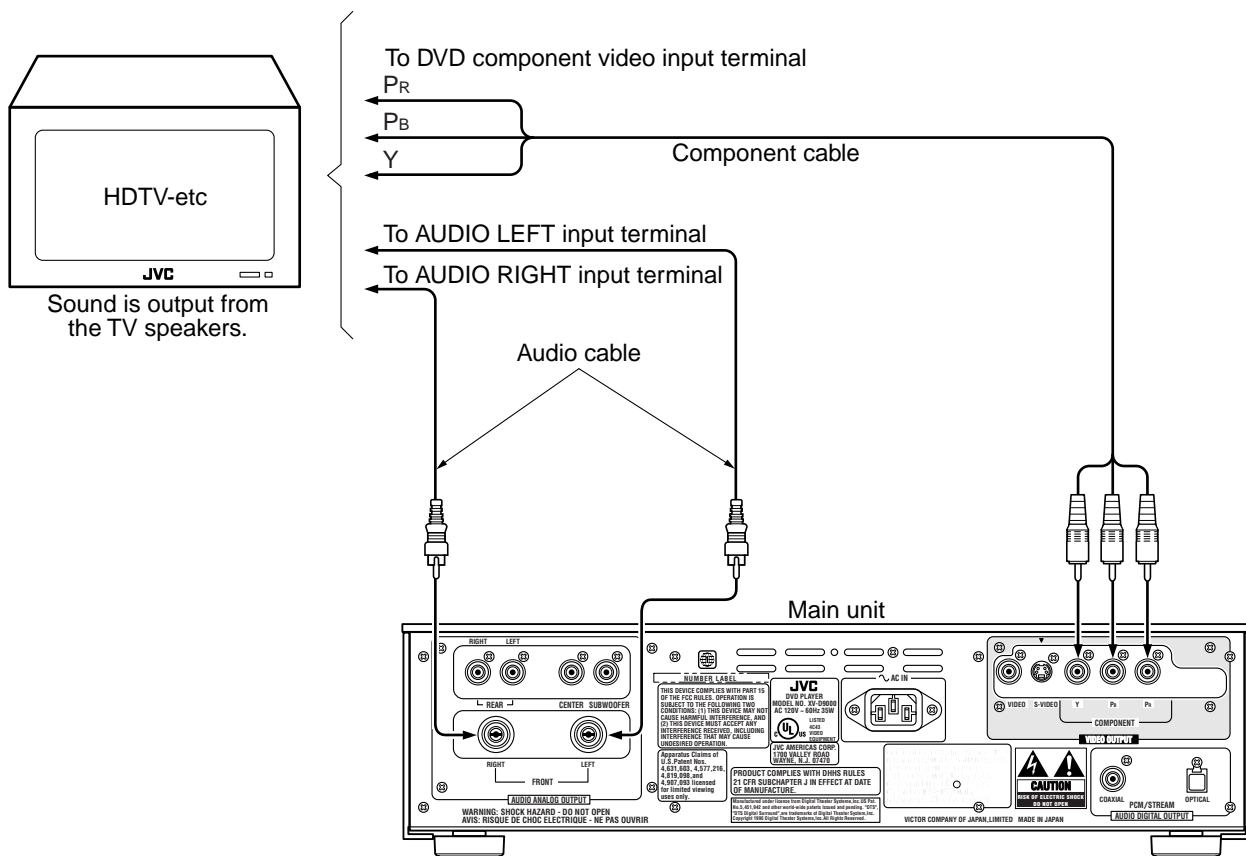

Note:

- If you connect the player to the “Y”, “P_B” and “P_R” terminals of a Progressive TV or High-Definition TV, you can enjoy progressive video output. Set the [PROGRESSIVE] in Initial Settings 2 of the Initial Settings screen to a setting other than [OFF] ([VIDEO] or [FILM]). See page 28.
- You should note that not all Progressive TV and High-Definition TV sets are fully compatible with this product and may cause artifacts to be displayed in the picture. In case of 525 progressive scan picture problems, it is recommended that you switch the setting to the “standard definition” output by setting the [PROGRESSIVE] in Initial Settings 2 of the Initial Settings screen to [OFF]. If there are questions regarding your JVC TV set compatibility with this model 525P DVD player, please contact our customer service center.
- All JVC Progressive TV and High-Definition TV sets have no problem. (Example: AV-61S902)

Connecting to a TV

You can also use the player by simply connecting it to a normal TV. To enjoy the advanced sound quality, connect the audio output to specialist audio equipment. See pages 10, 11, and 12.

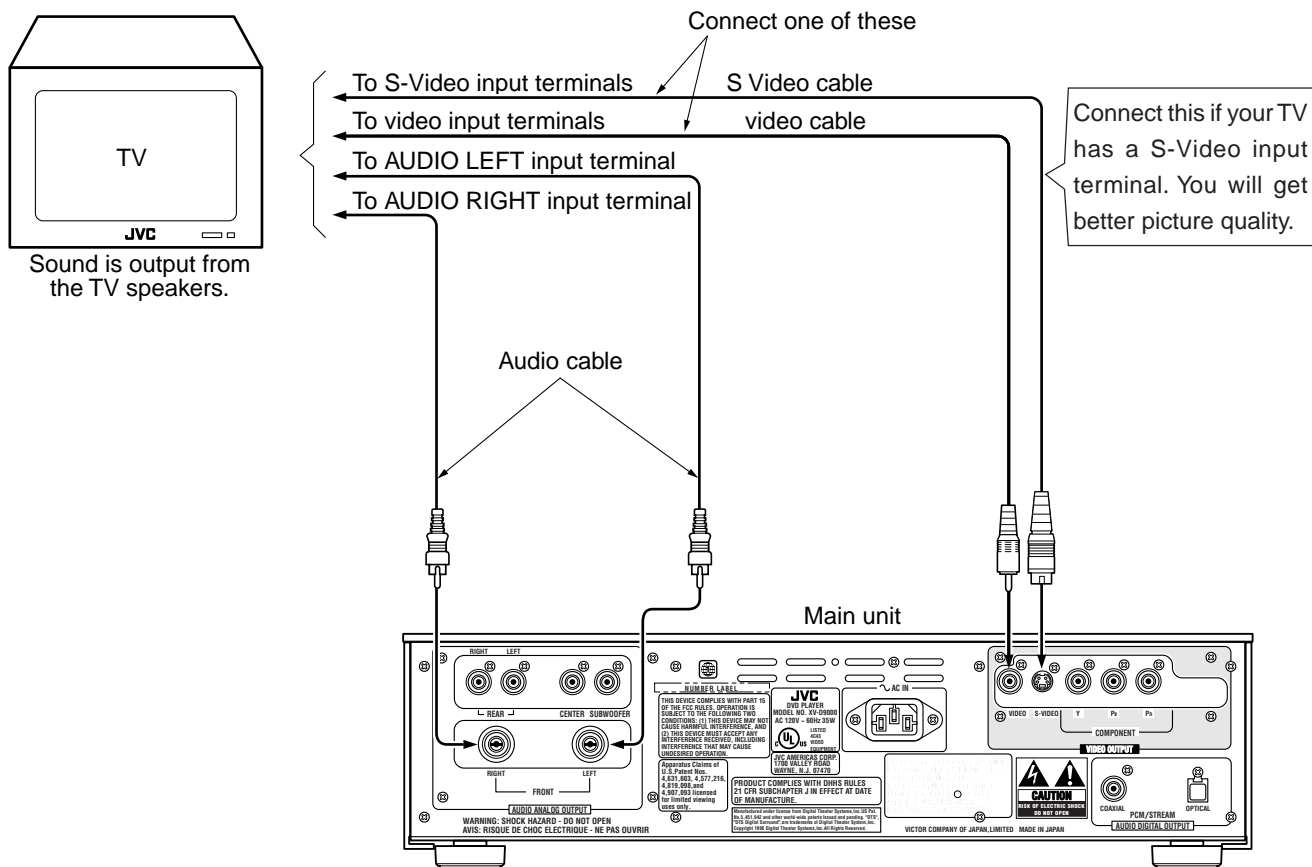

S-Video Signal

S-Video separates the luminance signal (Y) and color signal (C) of previous video signals. It achieves vivid images in which color blur is rare.

Connecting to an Amplifier or Receiver

By connecting the output from the player to speakers via a receiver or receiver you can enjoy realistic sound.

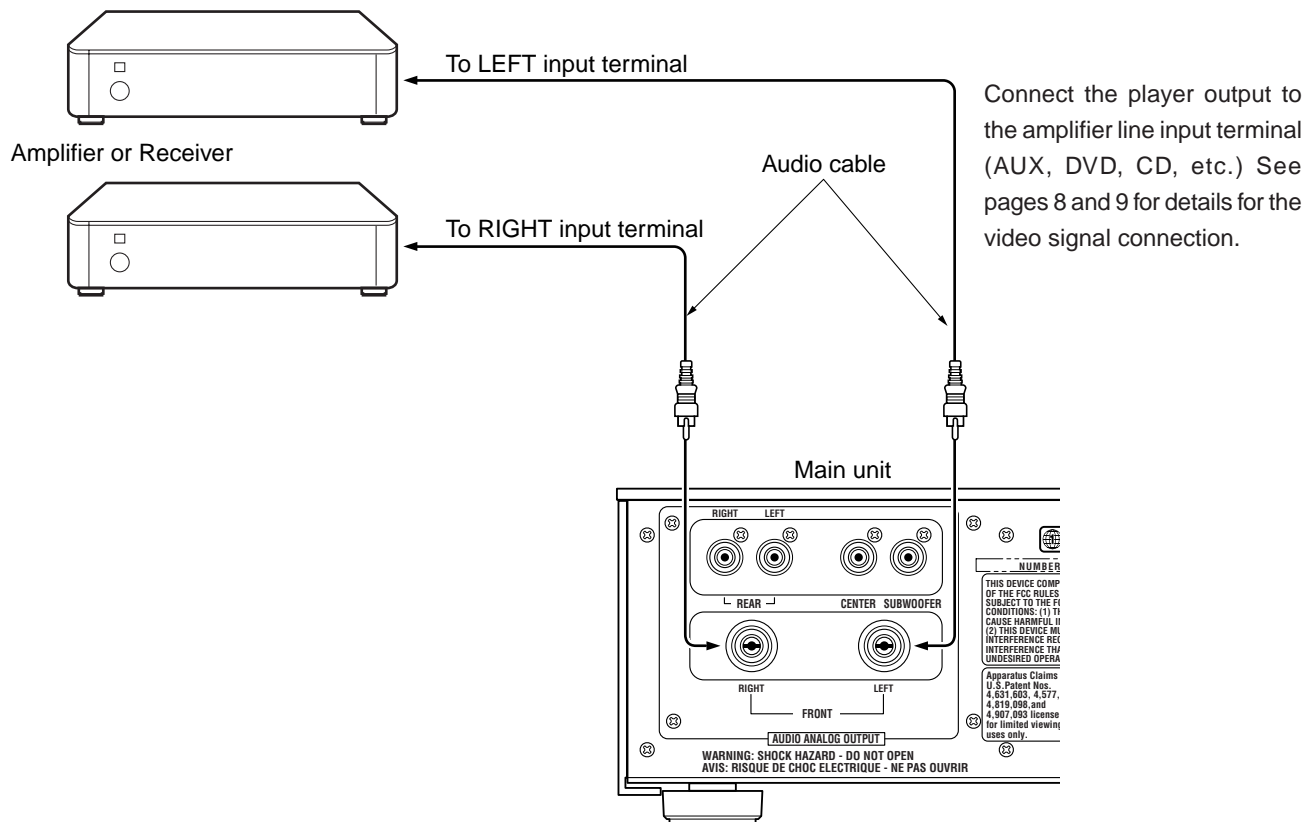

After you have setup the connection...

● Downmix Settings

When playing DVD Audio, Dolby Digital, and DTS multi-channel discs the downmix settings are used. These settings mean that even when multi-channel discs are played back in two stereo channels, they use not only the front left and right channels, but also use the other channel information. Set [DOWNMIX] in Initial Settings 2 of the Initial Settings screen to [Lt/Rt] or [Lo/Ro]. See page 28.

- If [DOWNMIX] is set to [OFF], you can hear only front left and right channel sound.
- Some multi-channel DVD Audio discs prohibit downmixing. In these cases sound will only be output of the front left and right channels.

Connecting to a Receiver with a 5.1 Channel Input Terminal

The player has a built-in DVD Audio decoder, Dolby Digital decoder and DTS decoder, which means that external decoders are unnecessary. By connecting the 5.1 ch output terminal of the player to the 5.1 ch input terminal of the receiver, you can enjoy realistic multichannel playback.

See pages 8 and 9 for details for the video signal connection.

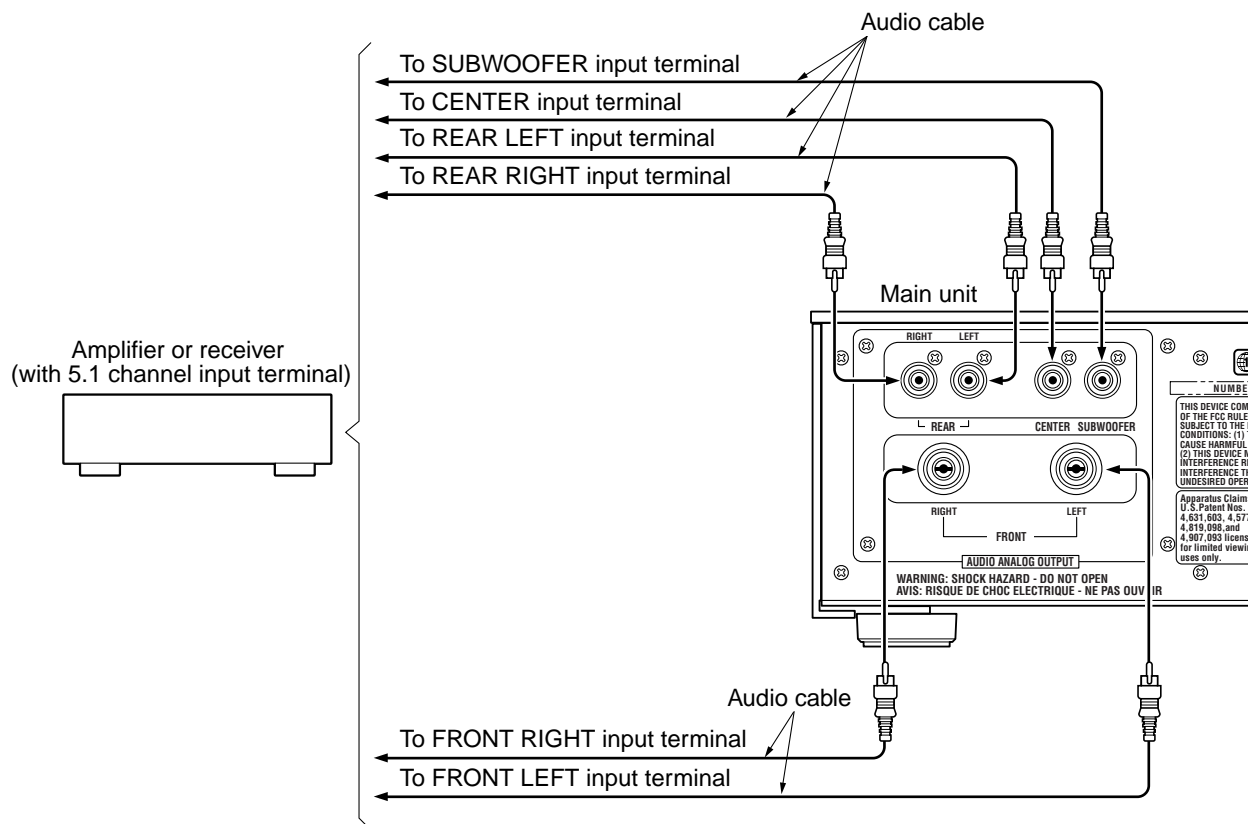

After you have setup the connection...

- **Speaker Settings**

Set Speaker Settings of the Initial Settings screen to [5.1 CHANNEL] or [EXPERT]. See pages 29 and 30.

- **Downmix Settings**

Set [DOWNMIX] in Initial Settings 2 of the Initial Settings screen to [OFF]. See page 28.

Connecting to a Device with a Digital Input Terminal

By connecting the digital output from this player to the digital input terminal of a receiver etc., you can send the digital audio signal from discs to external devices without changing the signal. Also, by connecting to Dolby Digital or DTS decoders (or amplifiers with built-in decoders), you can enjoy high-quality surround audio.

See pages 8 and 9 for details for the video signal connection to a TV.

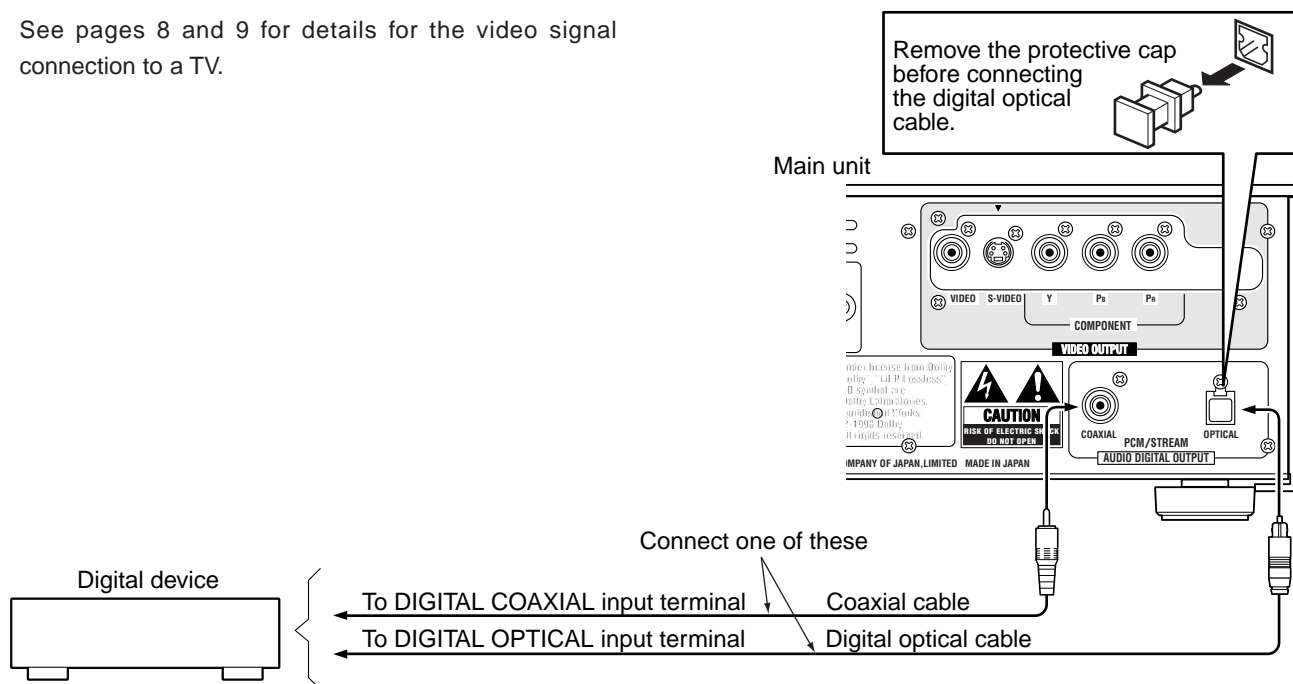

After you have setup the connection...

● Digital OUT Settings

Set [DIGITAL] OUT in Initial Settings 2 of the Initial Settings screen to match the connection to the external device. See page 27.

Note:

● When connecting to devices with Dolby Digital or DTS decoder functions

The [COMPRESSION] and [DOWNMIX] settings in Initial Settings 2 of the Initial Settings screen will not be applied to the digital output from the player. Make any adjustments for these settings with the external decoder.

● DVD Audio digital output

When recording the DVD Audio multi-channel digital output, the digital output is downmixed to two channels.

What is DTS (Digital Theater System)?

DTS is a new surround format that has better data compression to Dolby Digital that delivers superior quality surround playback of audio. It uses the same 5.1 channel that Dolby Digital uses, but due to lower audio compression during recording it produces audio with more depth and high S/N playback. It's wide dynamic range allows it to produce magnificent sound with excellent audio separation.

Connecting to the Power Supply

Use the power cord provided to connect the player to the power supply.

Insert the connector of the power cord into the power connector slot on the rear panel before inserting the power plug into the power outlet.

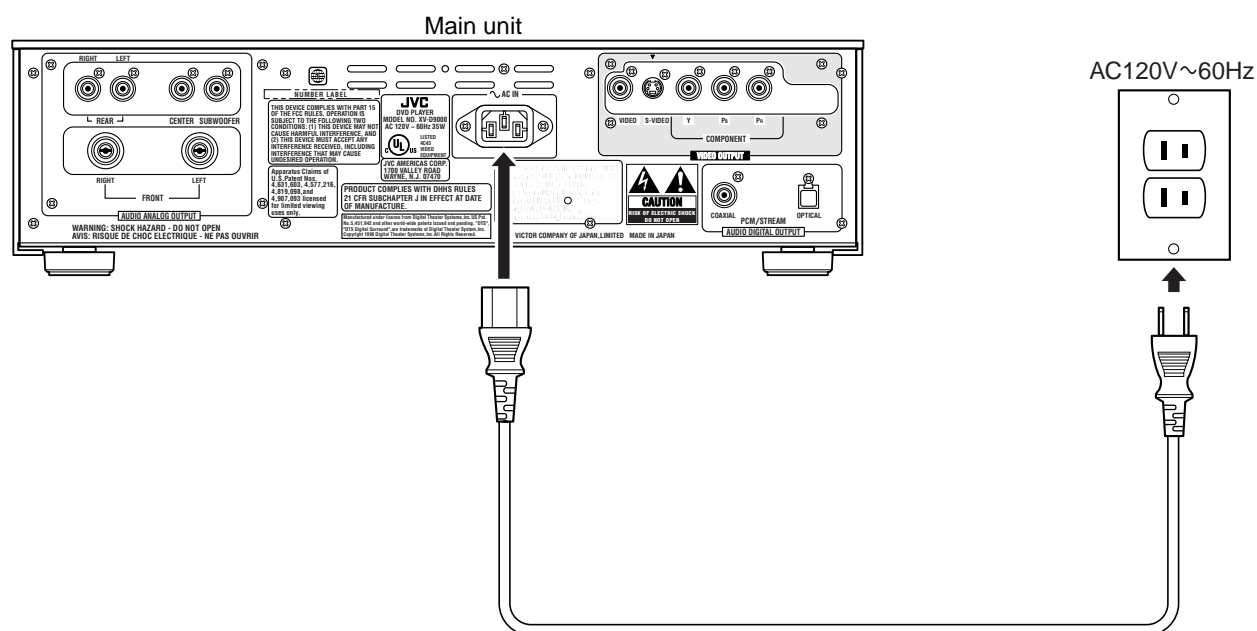

- The AC power cord of this unit has certain one-way direction connections to prevent electric shock.
- Always connect the player directly to a wall power outlet.

CAUTION

Only use the power cord provided with the player.

If you use a different cable, it may cause a malfunction or a fire hazard.

Preparing the Remote Control

- You can use the remote control to control the player.

The rear of the remote control includes a compartment for batteries.

- 1 While pressing the upper section of the battery compartment cover, lift off the cover.**

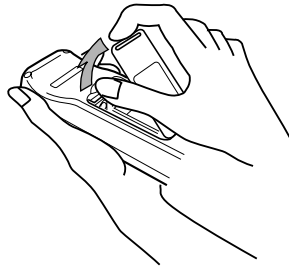

- 2 Insert AAA dry-cell batteries.**

Make sure that the + and - poles of the batteries are the same as indicated inside the battery compartment.

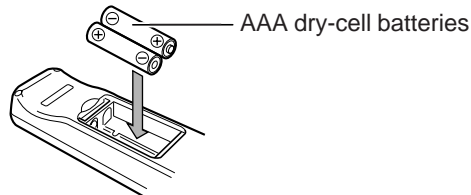

- 3 Close the battery compartment cover.**

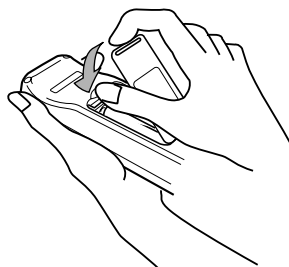

Note:

- When the operation range of the remote control is reduced, or if you can only use it when very close to the main unit, it is time to replace the batteries. Replace both batteries with new AAA batteries. Although the battery life will vary depending on amount of use and operating conditions, the batteries should last for six months, or so.
- If you will not be using the player for an extended period, remove the batteries from the remote control.

Parts and Their Functions

Front Panel

This allows you to perform basic operations for the player. The buttons on the front panel are all available on the remote control and the functions of both buttons are the same.

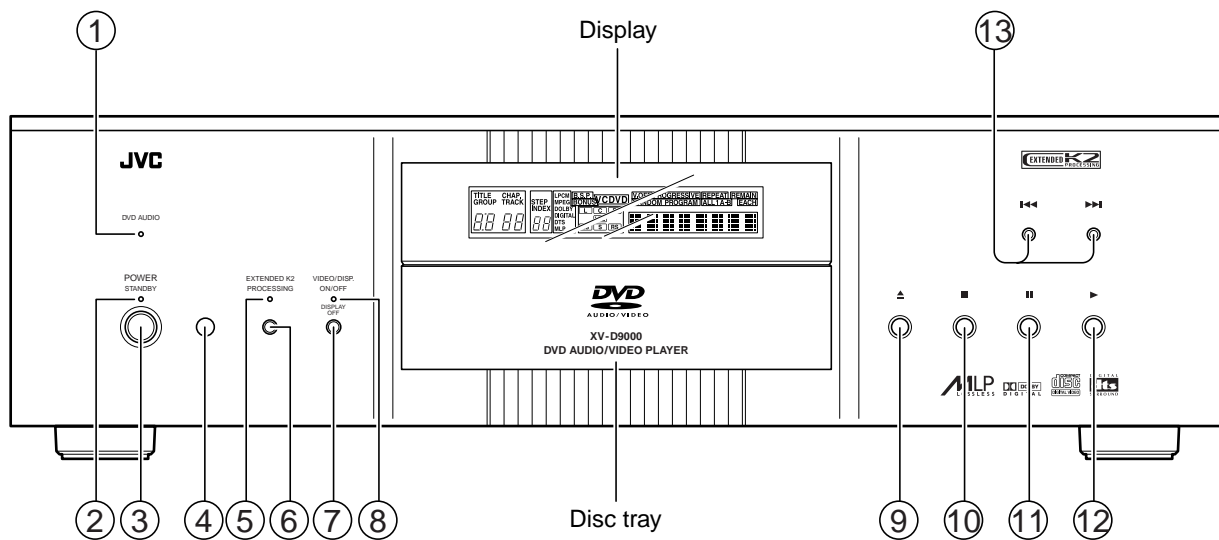

- ① **DVD AUDIO Indicator (blue)**
This lights when you insert a DVD Audio disc.
- ② **POWER STANDBY Indicator (red)**
This lights when the player is switched off. When the player is switched on, this indicator goes out.
- ③ **POWER/STANDBY Switch**
Switches the power on and off.
- ④ **Remote Control Optical Sensor**
Receives the control signals from the remote control.
- ⑤ **EXTENDED K2 PROCESSING Indicator (orange)**
This lights when Extended K2 Processing function is on.
- ⑥ **EXTENDED K2 PROCESSING Button**
Switches the Extended K2 Processing function on and off. See page 63.
- ⑦ **VIDEO/DISP.ON/OFF Button**
Each press of this button switches the video output from the main unit on or off, and switches the display mode. See page 38.
- ⑧ **DISPLAY OFF Indicator (orange)**
This lights when the display mode is off.
- ⑨ **▲ (Open/Close) Button**
This opens or closes the disc tray. It can also be used to turn the power on.
- ⑩ **■ (Stop) Button**
This stops playback of a disc that is playing.
- ⑪ **⏸ (Pause) Button**
This pauses playback of a disc that is playing.
- ⑫ **▶ (Play) Button**
This starts playback of a disc in the disc tray. It can also be used to turn the power on.
- ⑬ **⏮/⏭ (Skip) Buttons**
Use these to jump to the next/previous scene, or to jump to the next/previous track.
By pressing this button continuously during playback, you can fast forward/backward through the disc. Playback returns to normal mode when you release the button.

Display Section

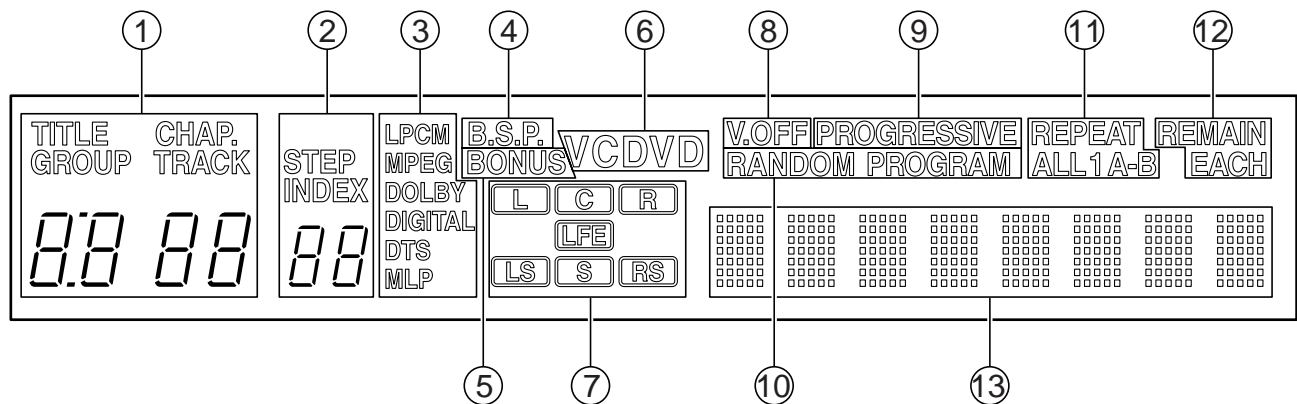

① TITLE/CHAP./GROUP/TRACK Display

For DVD Audio, this displays the Group number and Track (song) number.

For DVD Video, this displays the Title number and Chapter (song) number.

For Audio CD or Video CD, this displays the Track number.

② STEP/INDEX Display

STEP : Displays the program step number for programmed tracks.

INDEX : Displays the index number recorded on the disc.

- Displayed for DVD Audio and Audio CD discs.

③ Signal Format Display

When you play a disc, this displays the audio signal format used by the disc.

LPCM : Linear PCM format

MPEG : MPEG format

DOLBY DIGITAL : Dolby Digital format

DTS : Digital Theater System format

MLP : Meridian Lossless Packing format (lossless compression for DVD Audio)

④ B.S.P. (Browsable Still Pictures) Display (red)

This indicates if you can freely select the still images stored on a DVD Audio disc. When this is lit you press the PAGE +/- buttons on the remote control to select a still image.

⑤ BONUS Display

This lights when there is a bonus group in a DVD Audio disc.

- Not all discs include bonus groups.

⑥ Disc Type Display

Displays DVD, CD, or VCD (Video CD) as appropriate for the disc.

⑦ Audio Channel Display

Displays the audio channel information stored on a disc.

- For stereo two channel audio

L **R** lights.

- For 5.1 multi-channel format audio

L **C** **R**

LFE lights.

LS **RS**

L,R : Front left/right

C : Center

LS,RS : Rear left/right

LFE : Subwoofer low frequency signal

⑧ V.OFF Display (red)

When V.OFF is lit, you can switch off the video output when playing DVD Audio or Audio CD discs. By pressing the DISPLAY OFF button on the remote control or the VIDEO/DISP.OFF on the player, you can turn the V.OFF display on.

See page 38.

⑨ PROGRESSIVE Display (red)

This lights when Progressive Mode of the Initial Settings screen is set to [VIDEO] or [FILM].

See page 28.

⑩ Play Mode Display

Displays the function being used.

⑪ Repeat Display

Displays the function being used.

⑫ Time Display Mode

Displays the selected time display mode.

⑬ Message/Time Display

Displays any messages from the player or playback time of the disc.

Rear Panel

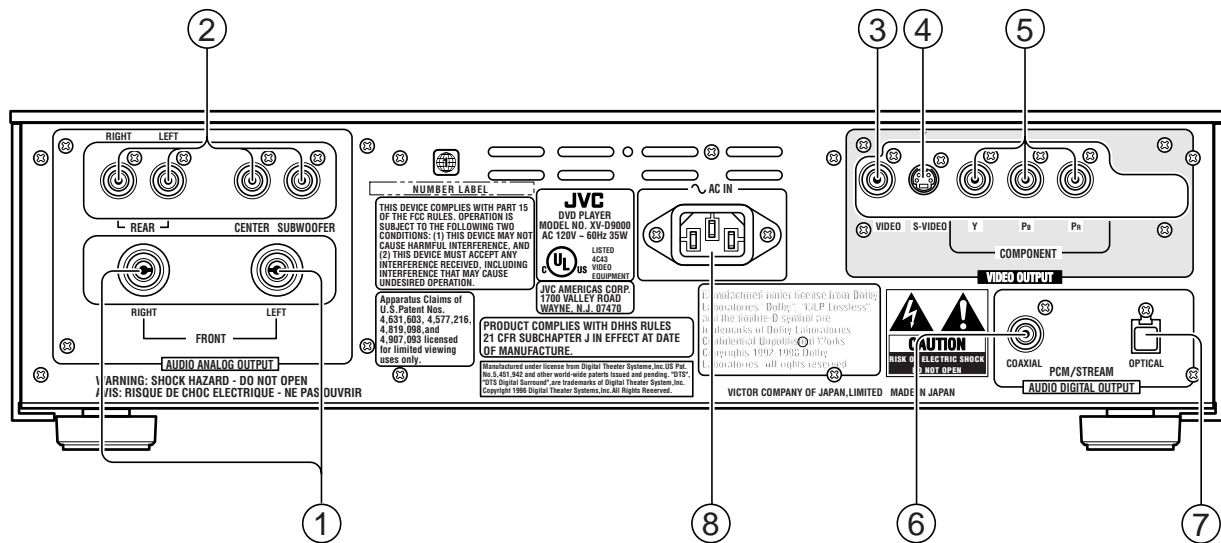

● Analog Audio Output Terminals

Use these terminals to connect the analog output from the player to a TV or analog amplifier.

① FRONT Terminals

These terminals are for connecting the analog audio output for the front left/right channels.

② REAR/CENTER/SUBWOOFER Terminals

These terminals are for connecting the analog audio output for the rear left/right, center, and subwoofer channels. They are used for multi-channel format configurations.

● Video Output Terminals

Use these terminals to connect the video output from the player to a TV etc.

③ VIDEO Terminal

Outputs the video signal (composite signal.)

④ S-VIDEO Terminal

Outputs the S-video signal.

⑤ COMPONENT (Component Video) Terminals

Outputs the component video signals.

- These can also be connected to a progressive TV or high-definition TV. See page 8.

● Digital Audio Output Terminals

Use these terminals to connect the digital audio output from the player to a device with digital input terminals.

⑥ COAXIAL Terminal

Outputs the digital audio signal.

⑦ OPTICAL Terminals

Outputs the digital audio signal.

● Power Connector

⑧ Power Connector

Connects to the power cord provided with the player.

Remote Control

The buttons on the front panel are all available on the remote control.

The functions of the buttons are the same.

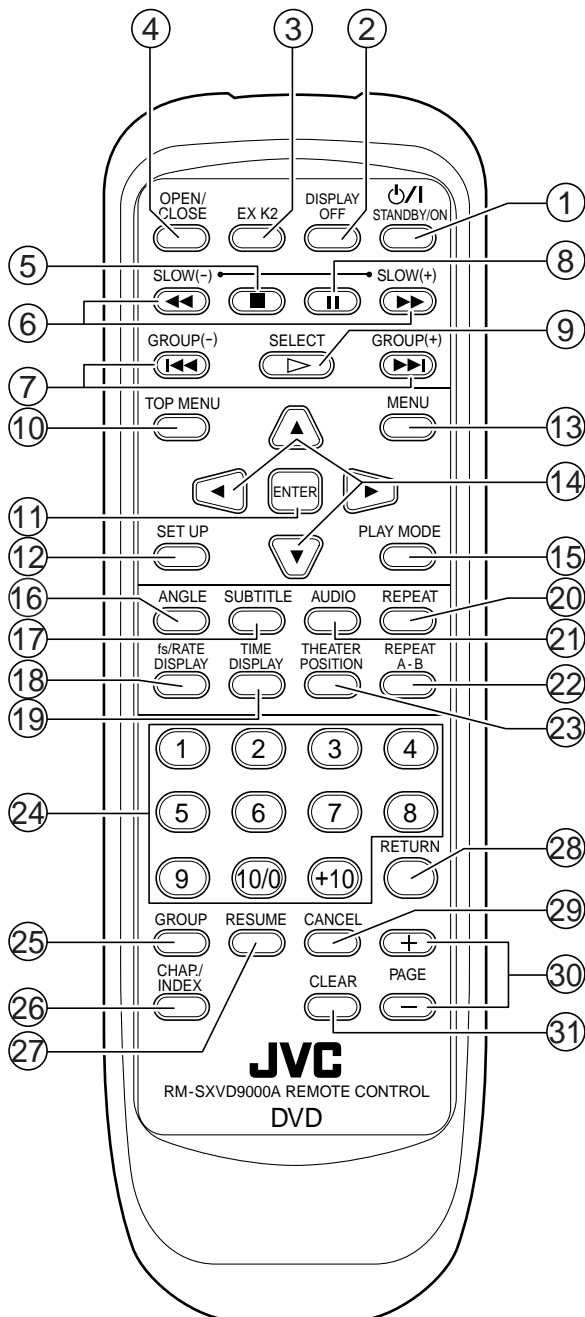

- ① **STANDBY/ON Switch**
Switches the power on and off.
- ② **DISPLAY OFF Button**
Each press of this button toggles the video output from the main unit on or off, and switches the display mode. See page 38.
- ③ **EX K2 Button**
Switches the Extended K2 Processing function on and off. See page 63.
- ④ **OPEN/CLOSE Button**
This opens or closes the disc tray. It can also be used to turn the power on.
- ⑤ **■ (Stop) Button**
This stops playback of a disc that is playing.
- ⑥ **⏩/⏪ (Fast Forward/Backward) Buttons**
These can be used to play the disc faster than normal. They can also be used to play in slow motion.
- ⑦ **⏭/⏮ (Skip) Buttons**
Use these to jump to the next/previous scene, or to jump to the next/previous track. With pressing [GROUP] or [CHAP/INDEX] you can skip the group or index titles.
- ⑧ **⏸ (Pause) Button**
This pauses playback of a disc that is playing.
- ⑨ **▶ (Play) Button**
This starts playback of a disc in the disc tray. It can also be used to turn the power on.
- ⑩ **TOP MENU Button** **DVD AUDIO** **DVD VIDEO**
Press this to display the top menu of DVD Audio discs or the title menu of DVD Video discs on the screen. See pages 42 and 51.
- ⑪ **ENTER Button**
Press this to confirm a menu selection made from the on screen menus of DVD Audio or DVD Video discs.
- ⑫ **SET UP Button**
Press this to display the Initial Settings screen. See page 24.
- ⑬ **MENU Button** **DVD VIDEO**
Press this to display the menu screen for DVD Video discs. See page 51.
- ⑭ **▲/▼/▶/◀ (Cursor) Buttons**
Press these to select items in the menu screens or on-screen displays for DVD Audio and DVD Video discs.

⑮ PLAY MODE Button DVD AUDIO AUDIO CD VIDEO CD

Use this button to select the Play mode (Random play, Program play.)

- You can use this button while a DVD Audio, Audio CD, or Video CD is stopped. You can also use it to change Progressive mode when using progressive output. See pages 41, 45, 46, 60, and 61.

⑯ ANGLE Button DVD AUDIO DVD VIDEO

Use this button to change the angle when playing DVD Audio/Video discs that include multi-angle information. See page 47 and 53.

⑰ SUBTITLE Button DVD AUDIO DVD VIDEO

Use this button to switch of subtitles, when playing DVD Audio/Video discs that include subtitle information. You can also use it to hide subtitles. See pages 48 and 54.

⑱ fs/RATE DISPLAY Button

Use this button to display the fs (sampling frequency) or transmission bit rate of each channel for a disc that is playing. See page 38.

⑲ TIME DISPLAY Button DVD AUDIO AUDIO CD VIDEO CD

Use this button to display the playing time of a track or disc. See page 36.

⑳ REPEAT Button

Use this button to repeat a title, chapter, or repeat all the tracks or a single track on a disc. See pages 46, 47, and 52.

㉑ AUDIO Button DVD AUDIO DVD VIDEO VIDEO CD

Use this button to change the audio output when playing DVD Audio discs with audio selection information, or DVD Video and Video CD discs that include multi-audio information. See page 54.

㉒ REPEAT A-B Button

Use this button to repeat a specified section of a disc. See pages 47, 53, and 62.

㉓ THEATER POSITION Button
DVD AUDIO DVD VIDEO VIDEO CD

Use this button to change the brightness of the video image. See page 39.

㉔ Number Buttons

Use these buttons to select a group, track, index item, title, chapter or items in the on-screen menus.

- Using the number buttons

To specify numbers 1 to 10, simply press the corresponding button.

To specify numbers for 11 up, use the [+10] and [10/0] buttons.

Example: To specify number 24, press [+10] twice, then press [4].

To specify number 30, press [+10] twice, then press [10/0].

㉕ GROUP Button DVD AUDIO

Use this button to select groups on DVD Audio discs.

Enter the group number with the number keys while pressing this button.

See pages 37, 43, and 49.

㉖ CHAP/INDEX Button DVD AUDIO DVD VIDEO AUDIO CD

Use this button to select chapters in DVD Video discs, or index items on DVD Audio and Audio CD discs. Enter the number with the number keys while pressing this button.

See pages 44, 52, and 59.

㉗ RESUME Button

Use this button to resume play from a paused or stopped position.

You can resume play from a position where the ■ (Stop) button was pressed or the position when the power was switched off. See page 33.

㉘ RETURN Button DVD AUDIO VIDEO CD

Use this button to return to the previous menu screen.

If B.S.P. is lit while playing a DVD Audio disc, this returns to the specified still image on the disc.

Note:

- Even when B.S.P. is lit, some discs do not include a specified still image.

㉙ CANCEL Button

Use this button to cancel a track in a program.

㉚ PAGE +/- Buttons DVD AUDIO

If B.S.P. is displayed when playing a DVD Audio disc, use these buttons to browse forward/backward through the still images. See page 44.

㉛ CLEAR Button

Use this button to clear all the contents of a program.

Before You Start

This section describes some basic information you should know before you start using your player. It also describes the various types of discs that can be played with the player.

Opening Screen



This screen is displayed automatically when the power for the player is turned on. During playback of a disc, it changes to the disc screen.

- Since Audio CD discs do not include screen information, the opening screen is usually displayed for these types of discs.

Preventing Screen Burnin [Screen Saver]

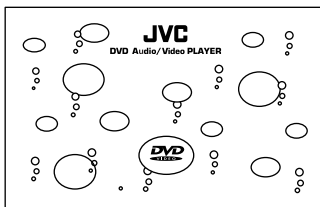

If a still image is displayed for a long time, a residual shadow of the image can be burnt into the TV screen. To prevent this from happening, the player has a screen saver function. If the Initial Settings screen, a paused image, menu or other still image is displayed for more than five minutes without any operations being performed, the screen is darkened and a moving image is displayed.

- The moving image is set in [SCREEN SAVER] of Initial Settings 2 in the Initial Settings screen.
- The screen saver function is cancelled when any of the operation buttons are pressed and the player returns to the original screen.

See page 28.

On-screen guide icons

When playing DVD Video/Audio discs, you may see icons displayed over the picture. These icons have the following meanings:



This icon is displayed at the beginning of the multi-angle information included on some discs. If this icon appears while you are playing a disc, you can change the angle used. See pages 47 and 53.





This icon is displayed at the beginning of the multilingual information included on some discs. If this icon appears while you are playing a disc, you can change the audio language used. See page 49.



This icon is displayed at the beginning of the multiple subtitle information included on some discs. If this icon appears while you are playing a disc, you can change the subtitle language used. See pages 48 and 54.

You can also setup the player so that these icons are not displayed. Set from the GUIDE setting in Initial Settings 1 of the Initial Settings screen. See page 26.





If appears during operation...

If  appears when you try to perform an operation, it means that you cannot use that function. Depending on the type of disc, you may not be able to perform some operations even if  is not displayed on the screen.

Depending on the type of disc, you may not be able to use the fast forward/backward, pause, slow motion playback and other functions. In these cases the operations will be invalid.

Types of Disc Supported by this Player

The types of disc that can be played by this player are as shown below.

Discs that can be played	Content type	Disc size
DVD Audio 	Audio + Video	12 cm
		8 cm
DVD Video 	Audio + Video	12 cm
		8 cm
Video CD  	Audio + Video	12 cm
		8 cm
Audio CD 	Audio	12 cm
		8 cm

Discs that cannot be played

- DVD-ROM
- DVD-RAM
- DVD-R
- DVD-RW
- CD-EXTRA
- CD-G
- CD-R
- CD-RW
- CD-ROM
- Photo CD
- CD TEXT

You cannot playback these types of disc. If you try to playback these kinds of discs, you may only get noise playback. This noise may damage your speakers.

For CD-G, CD EXTRA, and CD TEXT discs you can playback the audio only.

Regional code (local code)

The regional codes in DVD Video disc restrict the geographical region in which a disc can be played. If the regional code in the DVD Video disc does not match the codes of the DVD player, you cannot play the disc. The regional code for this player is 1, so you can playback DVD Video discs that have the number 1 on them.

- Examples of DVD Video discs that can be played by this player.



This player can playback discs that conform to the NTSC format. It cannot playback discs that use PAL or SECAM formats, such as those used in Europe.

Note:

- The playback requirements for DVD Audio, DVD Video and Video CD discs are determined by the software manufacturer. This player depends on the contents produced by the software manufacturer, therefore, some functions may not work as intended.

Disc Composition

DVD Audio discs

Generally, DVD Audio discs consist of up to nine groups, called Groups. Each Group can contain up to 99 tracks (songs).

In addition, each Group can also contain up to 99 index items.

Example of DVD Audio disc composition

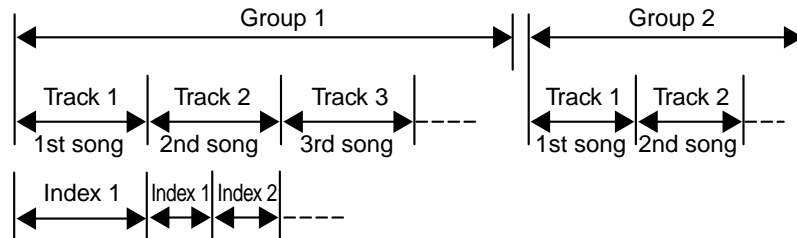

* Some discs also include bonus groups that have not been publicized. When you insert one of these discs, BONUS appears on the display.

DVD Video discs

Generally, DVD Video discs consist of a number of large sections, called Titles. Each Title has its own number (Title number) so that you can quickly access the title you want to watch. Titles can also be made up of a number of smaller sections called Chapters. Each Chapter also has its own number (chapter number) so that you can quickly access the chapter you want to watch. However, not all discs are divided into Titles or Chapters.

Example of DVD Video disc composition

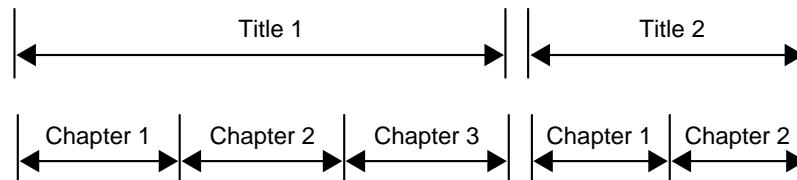

Audio CD and Video CD discs

Generally, Audio CD discs are divided into a number of individual songs, called Tracks. Each Track has its own number (Track number). For example, the second song becomes Track 2. Karaoke Video CD discs, etc., are the same. However, some discs are not divided into Tracks.

Audio CD discs can also contain up to 99 index items.

Example of Audio CD disc composition

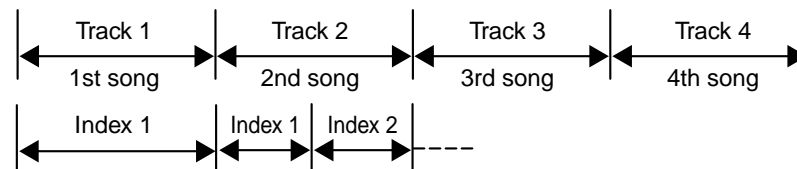

Switching the Power On

- When the power is switched off, the STANDBY indicator comes on.

■ When the STANDBY indicator is on

1 Press the STANDBY/ON button on the remote control or the player itself.

The power is switched on and the STANDBY indicator goes out.

- The opening screen is displayed on the TV screen.

If you press the STANDBY/ON button on the remote control or the player again, the power is switched off and the STANDBY indicator lights.

- The opening screen disappears from the TV screen.

One-Touch Operation

● ► (Play) Button

Pressing ▷ on the remote control or ► on the player switches the power on.

If a disc is in the disc tray, playback of the disc starts.

● OPEN/CLOSE Button

Pressing [OPEN/CLOSE] on the remote control or ▲ on the player switches the power on and the disc tray is ejected.

Note:

- The player is designed so that it uses a very small amount of electricity even when it is switched off. If you will not be using the player for an extended period of time, unplug the power cord from the power outlet.

Initial Settings

- Before using the player, set up the Initial Settings to match your system configuration.
- You can set up the Initial Settings while a disc is stopped or there is no disc loaded in the player.
- You can perform these operations from the remote control.

The Initial Settings screen consists of the following three screens.

- Initial Settings 1, Initial Settings 2
 - These settings are used to set up the settings for playing DVD Audio and DVD Video discs.
- Speaker Settings
 - These settings are used to adjust the settings to match the speakers connected to the player.

Setting Up the Initial Settings

1 Remove the disc from the disc tray.

- Or stop the disc.

2 Press [SET UP].

The Initial Settings screen is displayed.

To switch between the various Initial Settings screens, press ◀▶ to align the arrow (➤) with the tab.

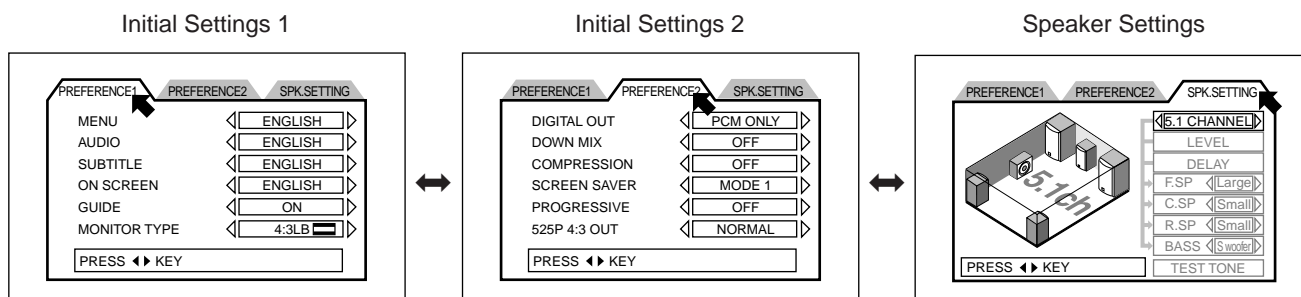

3 Press ▲/▼ to align the arrow (➤) with the item you want to select.

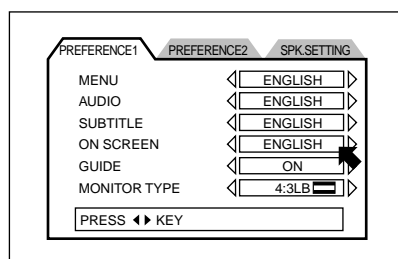

4 Press ◀▶ to select the setting.

Each time you press ◀▶ the display changes and the displayed setting is selected.

5 Repeat steps 3 and 4 for each setting.

- After you have finished making the settings, press ▲/▼ continuously until the arrow appears in the tab again. Then press ◀▶ to select the next screen.

6 When you have finished making all the settings, press [SET UP].

The display returns to the normal display.

PREFERENCE 1 Settings

MENU

Some DVD Video discs include menus in several languages. When playing these discs you can specify which language should be used when displaying the menus when they first appear.

Each time you press ►, the language changes in the order shown below. By pressing ◀, you can go through the languages in reverse order.

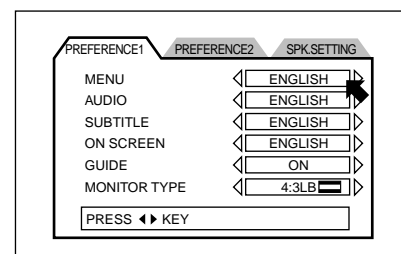

ENGLISH→SPANISH→FRENCH→CHINESE→GERMAN→ITALIAN→JAPANESE→additional language codes from AA to ZU.

See page 68.

* If the specified menu language is not included on a disc, the menu is displayed in the language included on the disc.

AUDIO

Some DVD Video discs include audio in several languages. When playing these discs you can specify which language should be used for the audio when the disc is first played.

Each time you press ►, the language changes in the order shown below. By pressing ◀, you can go through the languages in reverse order.

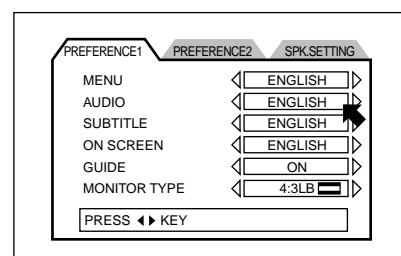

ENGLISH→SPANISH→FRENCH→CHINESE→GERMAN→ITALIAN→JAPANESE→additional language codes from AA to ZU.

See page 68.

* If the specified audio language is not included on a disc, the audio is played using the language included on the disc.

SUBTITLES

Some DVD Video/Audio discs of foreign language films include subtitles in several languages. When playing these discs you can specify which language should be used when displaying the subtitles for the first time.

Each time you press ►, the language changes in the order shown below. By pressing ◀, you can go through the languages in reverse order.

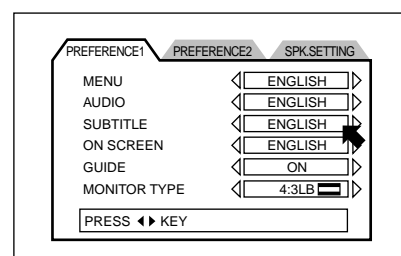

ENGLISH→SPANISH→FRENCH→CHINESE→GERMAN→ITALIAN→JAPANESE→additional language codes from AA to ZU.

See page 68.

* If the specified subtitle language is not included on a disc, the subtitles are displayed in the language included on the disc.

ON SCREEN

You can change the on screen language.

Each time you press ◀▶ the language switches between English and French.

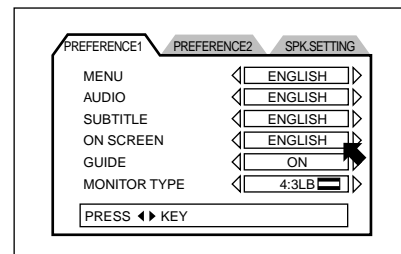
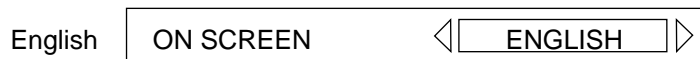

GUIDE

The player includes a function that allows it to display on-screen guide icons while a disc is playing. These icons can help you understand what is stored on the discs and how to use the player itself. You can also set up the player so that these are not displayed.

- **ON:** The on-screen guide are displayed.
- **OFF:** The on-screen guide are not displayed.

Example: , etc.

See page 20.

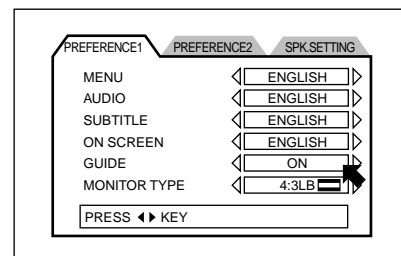

MONITOR TYPE

If you have connected the player to a wide-screen TV (horizontal /vertical ratio of 16:9), select 16:9 WIDE. If the player is connected to a standard TV (horizontal /vertical ratio of 4:3), select either 4:3PS or 4:3LB according to your taste. Many DVD Video film titles are intended for playback on wide-screen TVs. When playing these titles on a standard TV they include converters for either the Pan Scan or Letterbox format. If the disc includes converters for both formats, you can choose which format to use.

- **4:3PS**

This format uses the same height as the original but clips the right and left edges of the picture.

Note:

- If the disc does not support the Pan Scan format, Letterbox is used.

- **4:3LB**

This format reduces the overall picture size and imposes a black mask at the top and bottom of the picture. It does not clip the right and left edges of the picture.

- **16:9 WIDE**

Select this format when connected to a wide-screen TV (horizontal /vertical ratio of 16:9). This displays the whole picture for 16:9 film titles.

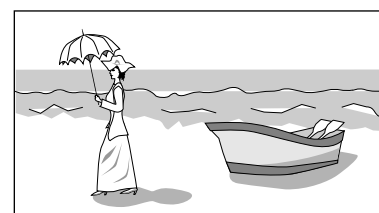
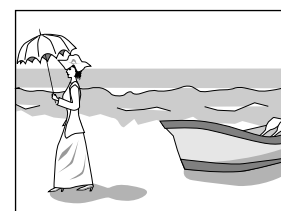

PREFERENCE 2 Settings

Digital Output

Depending on the device to which the Digital Audio Output terminal is connected, you have to change these settings to match the device.

- If there is nothing connected to the Digital Audio Output terminal, you do not need to adjust these settings.

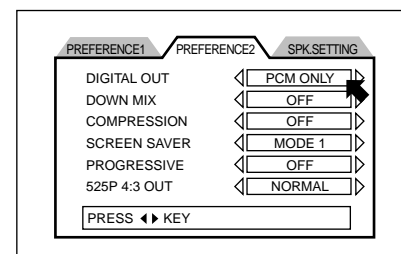

- **STREAM/PCM**

Use this setting if the player is connected to a receiver with DTS, Dolby Digital, and MPEG decoders or with separate decoders.

- **DOLBY DIGITAL/PCM**

Use this setting if the player is connected to a receiver with a PCM or Dolby Digital, decoder.

- **PCM ONLY**

Use this setting if the player is connected to a receiver with digital terminal that supports linear PCM output, or a DAT tape deck.

[Relation between disc types and output signals]

Disk type	Output		
	STREAM/PCM	DOLBY DIGITAL/PCM	PCM ONLY
44.1/88.2/176.4kHz, 16/20/24 bit linear PCM DVD Audio	44.1kHz, 16 bit linear PCM		
48/96/192kHz, 16/20/24 bit linear PCM DVD Audio	48kHz, 16 bit linear PCM		
44.1/88.2/176.4kHz, 16/20/24 bit MLP DVD Audio	44.1kHz, 16 bit linear PCM		
48/96/192kHz, 16/20/24 bit linear MLP DVD Audio	48kHz, 16 bit linear PCM		
48kHz, 16/20/24 bit linear PCM DVD Video	48kHz, 16 bit linear PCM		
96kHz, 16/20/24 bit linear PCM DVD Video	48kHz, 16 bit linear PCM		
DTS DVD Video	DTS bit stream	48kHz, 16 bit linear PCM	
Dolby Digital DVD Video	Dolby Digital bit stream		48kHz, 16 bit linear PCM
MPEG DVD Video	MPEG bit stream	48kHz, 16 bit linear PCM	
Audio CD	44.1kHz, 16 bit linear PCM		
DTS Audio CD	DTS bit stream	44.1kHz, 16 bit linear PCM	
Video CD	44.1kHz, 16 bit linear PCM		

DOWNMIX

This setting adjusts the signal output to the Audio Output terminal to match the connected device.

- **Lt/Rt:** Use this setting if the Audio Output terminal of the player is connected to a receiver with a built-in Dolby Pro Logic decoder.
- **Lo/Ro:** Use this setting if the Audio Output terminal of the player is connected to a TV or a receiver with a built-in Dolby Pro Logic decoder.
- **OFF:** Use this setting if the 5.1 ch Audio Output terminal of the player is connected to a receiver with a 5.1ch input terminal.

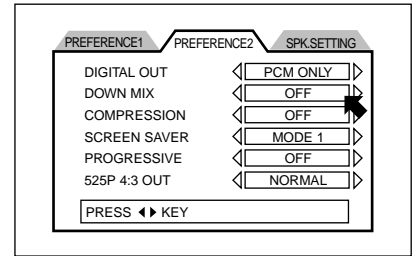

COMPRESSION

You can adjust the downmix range according to your needs.

- **ON:** This plays discs while suppressing the dynamic range. Use this for quiet films etc. and other discs where it is difficult to hear the audio.
- **OFF:** This plays discs using the original dynamic range.

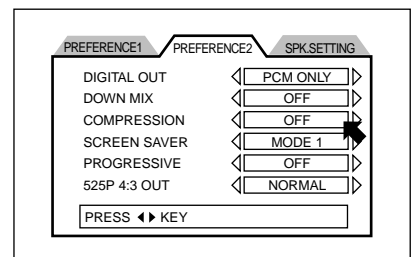

SCREEN SAVER

If a still image is displayed for a long time, a residual shadow of the image can be burnt into the TV screen. To prevent this from happening, the player has a screen saver function. If more than five minutes elapses without any operations being performed, the screen saver starts. You can choose the following settings.

- **MODE 1:** This mode uses a moving background.
- **MODE 2:** This mode uses a stationary background.
- **DIMMER:** This mode dims the screen.
- **OFF:** The screen saver function is switched off.

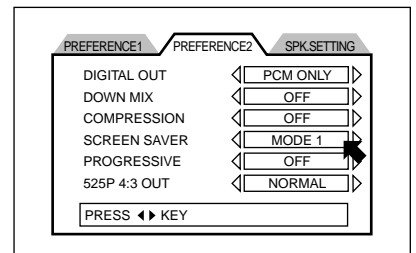

Note:

- If the Screen Saver function is set to OFF, be careful to ensure that image burn-in does not occur.
- If the Screen Saver function is set to MODE 1 and flickering occurs, change to a different setting.

PROGRESSIVE MODE

Adjust this setting to match the connected TV.

- **OFF:** Use this setting if the player is connected to a standard TV.
- **VIDEO or FILM:** Use this setting if the player is connected to Progressive TV or High-Definition TV. For most cases, you should use the Video setting.
Use the FILM setting when playing films to achieve even better picture quality.

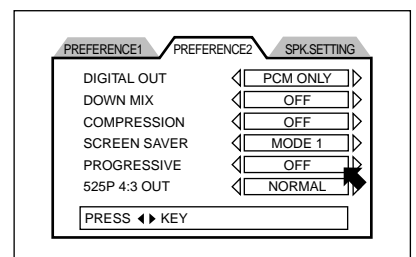

Note:

- These Progressing settings do not effect the video output for sources (S-VIDEO, VIDEO) other than component video terminal.

525P 4:3 OUT

When the COMPONENT terminal of the player is used for progressive output (525P) to a wide-screen TV (horizontal /vertical ratio of 16:9), some TVs fix the image size at the full 16:9 size. This means that when you play a disc that uses the standard 4:3 size, the left and right of the picture is stretched. If this happens, you can select [NORMAL] to automatically change the picture to the correct size ratio.

- **NORMAL:** The horizontal /vertical size is ratio changed to the correct ratio, and a black mask appears on the left and right of the picture. Since changes the resolution, the picture quality is reduced slightly.
- **FULL:** This stretches the left and right of the picture.

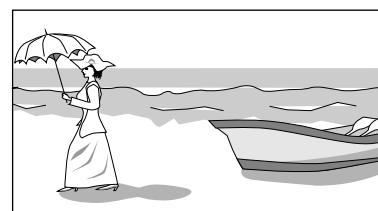
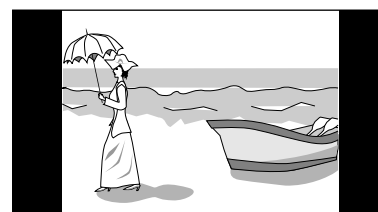

Note:

- The 525P 4:3 Output setting is only used to adjust the picture size ratio when playing video with progressive output. If the player is connected to a TV that does not support progressive output, or Progressive Mode is set to Off, the size ratio is not adjusted. You will need to make any adjustments on the TV itself.

SPK. SETTING Screen Settings

Use these settings to match the capabilities of the speakers connected to the player. In most cases, you should select either 2 Channel or 5.1 Channel. You can also select Expert which allows you to adjust the output balance or delay time.

Speaker Channel Settings

Adjust this setting to match the speaker system connected to the player.

- **2 CHANNEL:** Use this setting when the player is connected to a 2 channel amplifier or two speakers. The setting is completed simply by selecting [2 CHANNEL].
- **5.1CHANNEL:** Use this setting when the player is connected to a 5.1 channel amplifier and you are using front, rear, center, and subwoofer speakers. The settings are completed simply by selecting [5.1 CHANNEL].
- **EXPERT:** This setting allows you to make detailed adjustments to the output to match your speakers. It is intended for experienced audio experts.

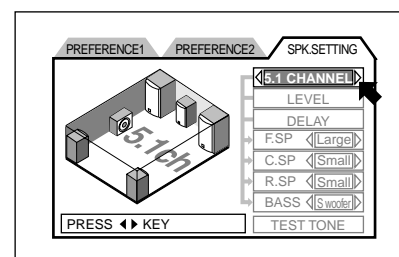

Note:

- These settings are only effective for analog audio output. If you are using digital audio output, adjust the speakers settings on the external decoder.

Expert Settings

● Speaker Size Settings

Select the speaker size for the speakers you are using.

1 Press ▲/▼ to select the type of speaker.

- F.SP (Front speakers)
- C.SP (Center speaker)
- R.SP (Rear speakers)

2 Press ◀/▶ to select the settings.

- Large: Large speakers capable of playing bass tones.
- Small: Small speakers that do not reproduce bass tones well.
- None: There is no speaker connected to that channel.

If you select [SMALL] for the front speakers, you cannot select [LARGE] for any of the other speakers.

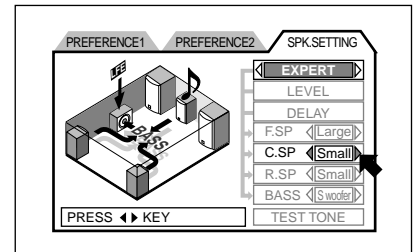

● Bass Redirect Settings

If you are using small speakers that cannot reproduce low tones well, you can redirect the bass audio to the subwoofer or front speakers.

1 Press ▲/▼ to select [BASS].

2 Press ◀/▶ to select the settings.

- S-woofer: Redirects the bass audio output to the subwoofer.
- L/R: Redirects the bass audio output to the front speakers.

If the front speakers are set to [SMALL], the bass audio is automatically redirected to the subwoofer.

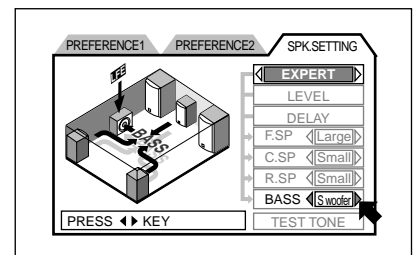

● Speaker LEVEL Settings

You can select the output level for each speaker, within a range of +6 dB to -6dB.

1 Press ▲/▼ to select [Level], then press [ENTER].

The Level Settings screen appears.

2 Press ▲/▼ to select the type of speaker.

- F.SP (Front speakers) is fixed at 0dB and cannot be adjusted.

3 Press ◀/▶ to select the desired output level.

- You can use the test tone to check the output level. See page 31.

4 Press ▲/▼ to select [LEVEL], then press [ENTER].

The Level Settings screen closes.

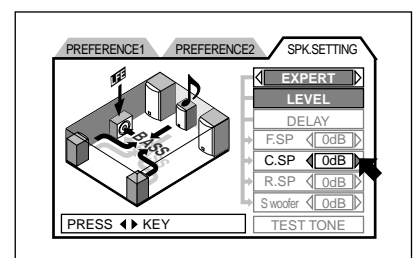

● Delay Time Settings

You can adjust the delay time for each speaker.

1 Press ▲/▼ to select [DELAY], then press [ENTER].

The Delay Time Settings screen appears.

2 Press ▲/▼ to select the type of speaker.

- F.SP (Front speakers) and S.WOOFER (Subwoofer) are at 0ms and cannot be adjusted.

3 Press ◀/▶ to set the desired delay time.

- You can adjust C.SP (Center speaker): within a range of 0ms to –5ms.
- You can adjust R.SP (Rear speakers): within a range of 0ms to –15ms.
- You can use the test tone to check the effect of the settings. See page 31.

4 Press ▲/▼ to select Delay, then press [ENTER].

The Delay Time Settings screen closes.

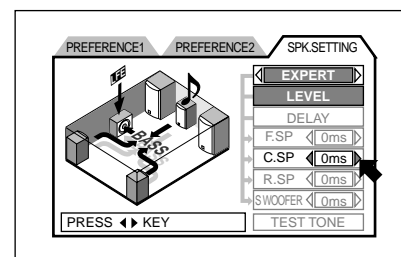

● Using the Test Tone

You can play a test tone when adjusting the speaker level or delay time.

1 While adjusting the speaker level or delay time, press ▲/▼ to select Test Tone, then press [ENTER].

You can play a test tone from all speakers except the subwoofer.





- To play the test tone from a specific speaker, press ▲/▼ to select the speaker.





2 Press ◀/▶ to adjust the Level or Delay setting.

3 Press ▲/▼ to select Test Tone, then press [ENTER] to stop the test tone.

Basic Operations

This section describes the basic procedures of how to insert a disc into the disc tray and how to play the disc.

- You can perform all operations with the remote control and basic operations from the player itself.
- The     symbols after titles in this section mean that these operations can be performed with the indicated types of disc.

Example:     Means that the operation can be performed on all discs.

Loading a Disc

- 1 Press [OPEN/CLOSE] on the remote control. (On the player itself, press )

The disc tray is ejected.

- 2 Place the disc on the disc tray.

Place the disc so it is aligned with the center of the disc tray. If the disc is not aligned correctly, it may be damaged when the disc tray closes or it may become jammed in the disc tray.

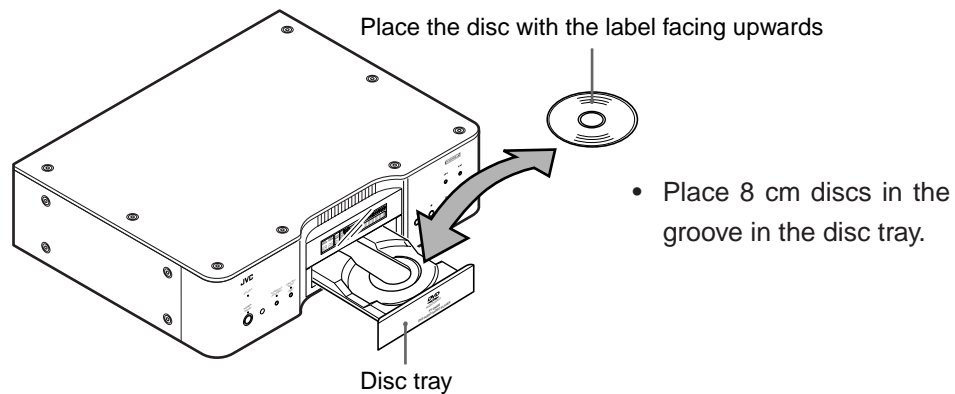

- 3 Press [OPEN/CLOSE] on the remote control. (On the player itself, press )

The disc tray closes.

Note:

- Be careful not to trap your fingers in the disc tray.

Playing a Disc

This section describes the procedure for basic operations. Play, stop, pause and skip.

Step-by-Step Procedure for Playing a Disc

1 Press ▷ (Play) (On the player itself, press ►.)

The disc is played starting at the beginning.

- DVD Video: Pressing ▷ displays the menu on the TV screen. In this case, you can select an item from the menu to playback. See page 51.
- Video CD : For Video CD discs that include PBC (Playback Control) information, pressing ▷ displays the menu on the TV screen. In this case, you can select an item from the menu to playback. See page 59.

Stopping a Disc

■ While a disc is playing

1 Press ■ (Stop). (On the player itself, press ■.)

Playback stops.

Pausing a Disc

■ While a disc is playing

1 Press II (Pause). (On the player itself, press II.)

Playback is paused.

■ Cancelling Pause

Press ▷ (Play). (On the player itself, press ►.)

Skipping Through a Disc

■ While a disc is playing

1 Press ►► or ◀◀. (On the player itself, also press ►► or ◀◀.)

►► : Skips ahead to tracks in the forward direction.

◀◀ : Skips back to tracks in the reverse direction.

- DVD Audio: For this type of disc you can skip across track numbers.
While pressing [GROUP], press ►► or ◀◀ to skip groups.
 - You can also use this procedure while a disc is stopped.
- DVD Video: Although it will depend on the contents of the disc, for most disc you skip across titles or chapters.
- Audio CD: For this type of disc you can skip across track numbers.
 - You can also use this procedure while a disc is stopped.
- Video CD: For this type of disc you can skip across track numbers.
When playing Video CD discs using PBC, you may not be able to skip tracks for some discs. For more information about PBC playback (using the menu function for normal playback), see page 58.
 - You can also use this procedure while a disc is stopped.

Fast Forward/Backward Through a Disc

You can perform these operations by pressing the fast forwards/backwards buttons on the remote control or the player itself.

Using the ►►/◄◄ buttons on the remote control to fast forward/backward through a disc.

■ While a disc is playing

1 Press ►► or ◄◄.

►►: Fast forward through a disc.

◄◄: Moves fast backward through a disc.

- The playback speed increases with each press of the button.

To resume normal playback

Press ▷ (Play).

Using the ►►/◄◄ buttons on the player itself to fast forward/backward through a disc.

■ While a disc is playing

1 Press and hold down ►► or ◄◄.

►►: Fast forward through a disc.

◄◄: Fast backward through a disc.

- When you release the ►►/◄◄ button, normal playback resumes.

Resume Playback [RESUME]

If you press the ■ (Stop) button while a disc is playing, that point is stored as the resume point. If you turn the power off, while a disc is playing, that point is stored as the resume point. If you continue playback from the resume point, you can continue from your previous session.

Storing the resume position

■ While a disc is playing

1 Press ■ (Stop).

The point at which the disc was stopped is stored as the resume point.

- If you turn the power off the point at which the power was switched off is stored as the resume point. (The resume point is remembered even if the power is switched off.)
- If you store a new resume point, the previous resume point is replaced by the new resume point.

Resuming Playback

■ While a disc is stopped or the power is OFF

1 Press [RESUME].

Playback starts from the stored resume point.

- When playing Video CD discs that use PBC, playback may resume from slightly before or after the stored resume point.
- If you use resume after stopping program or random playback, playback will start from the resume point using normal playback, not program or random playback. (For DVD Audio, Audio CD, and Video CD)

Clearing a resume point

If you open the disc tray, the stored resume point is cleared.

Example of basic resume playback

To continue playback from a previous session, press [RESUME] instead of [PLAY]. Playback resumes point where you stopped the previous session.

Viewing One Frame at a Time

You can view pictures one frame at a time.

- For DVD Audio discs, you can only view pictures one frame at a time if the disc includes video images. For discs that only include still pictures, or do not include any pictures,  is displayed.

■ While a disc is playing

1 Press **II** to pause playback.

2 Press **II**.

Each time you press the button, the paused image is advanced by one frame.

- Pressing , resumes normal playback.

Slow Motion Playback

You can perform slow motion playback by pressing the buttons on the remote control or the player itself.

- For DVD Audio discs, you can only use slow motion playback if the disc includes video images. For discs that only include still pictures, or do not include any pictures,  is displayed.

Using the **▶▶/◀◀** buttons on the remote control for slow motion playback.

■ While a disc is playing

1 Press **II** to pause playback.

2 Press **▶▶** or **◀◀**.

▶▶ : Uses slow motion playback in the forward direction.

◀◀ : Uses slow motion playback in the reverse direction. (Only for DVD Audio and DVD Video discs.)

The slow motion playback speed increases with each press of the button.

- Pressing , resumes normal playback.

Pausing slow motion playback

Press **II** (Pause).

Using the **▶▶|◀◀** buttons on the player itself for slow motion playback.

■ While a disc is playing

1 Press **II** to pause playback.

2 Press **and hold down** **▶▶|** or **|◀◀**.

▶▶| : Uses slow motion playback in the forward direction.

|◀◀ : Uses slow motion playback in the reverse direction. (Only for DVD Audio and DVD Video discs.)

- When you release the **▶▶|/|◀◀** button, the player returns to the paused state.

Note:

- The audio signal is not output during slow motion playback.
- You cannot use slow motion playback in the reverse direction for Video CD discs.

Playing Time Display [TIME DISPLAY]

While a disc is playing you can display the elapsed/remaining playing time for a track, the elapsed/remaining playing time for the disc. You can also display the playing time while a disc is stopped.

- You can perform these operations from the remote control.

Using time display during playback

■ While a disc is playing

1 Press [TIME DISPLAY].

Each time you press the button, the time display changes as shown below.

- When playing DVD Audio/Audio CD discs

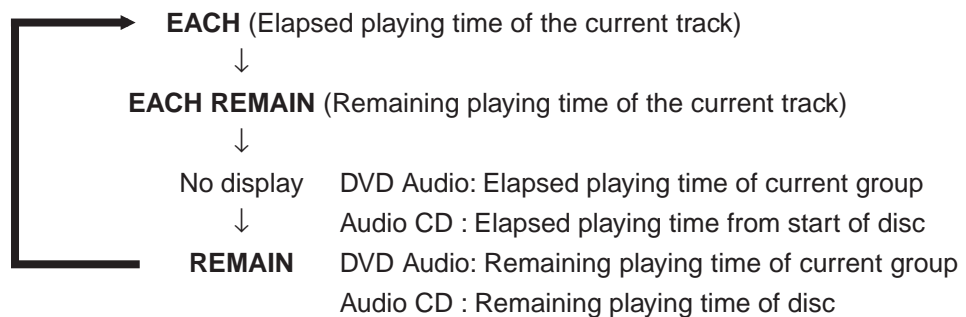

- When playing Video CD discs (with PBC Off)

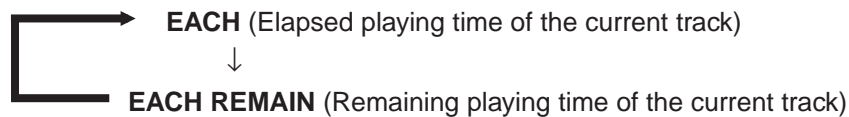

Note:

- You can only use time display for Video CD discs when PBC is set to Off. If PBC is set to On, the times are not displayed.

Using time display while a disc is stopped (using [TIME DISPLAY])

■ While a disc is paused

1 Press [TIME DISPLAY].

Each time you press the button, the time display changes as shown below.

- When Audio CD or Video CD discs are stopped (with PBC Off)

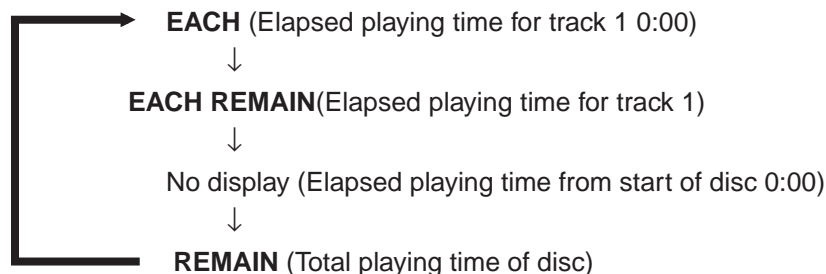

- When Video CD discs are stopped (with PBC On)



Note:

- For DVD Audio discs, you cannot display the playing time by pressing **[TIME DISPLAY]** while the disc is stopped.

Using time display while a disc is stopped

When you insert a disc or if you stop playback, the playing time display changes as shown below.

- For DVD Audio discs

(Total playing time of disc)
 ↓ Approximately five seconds later
REMAIN (Total playing time for the first group)
 ↓ Approximately five seconds later
 (Display when stopped)

You can view the playing time for each group by pressing **[GROUP]**, then pressing **▶▶|** (**[GROUP(+)]**) or **|◀◀** (**[GROUP(-)]**) to select each group.

- For Audio CD/Video CD discs

(Total playing time of disc)
 ↓ Approximately five seconds later
EACH REMAIN (Playing time for the first track)

You can view the playing time for each track by pressing **▶▶|** or **|◀◀** to select each track.

Turning the Display Off to Get Better Sound Quality [DISPLAY OFF]

If you do not need the picture display, you can switch off the video output. (For DVD Audio and Audio CD only)
By switching off the video output display while a disc is playing, you can eliminate noise generated by the video circuitry or the display. This allows you to achieve even greater sound quality from the player.

■ While a disc is playing or paused

1 Press [DISPLAY OFF]. (On the player itself, press [VIDEO/DISP.ON/OFF].)

Each time you press the button, the video output and display changes as shown below.

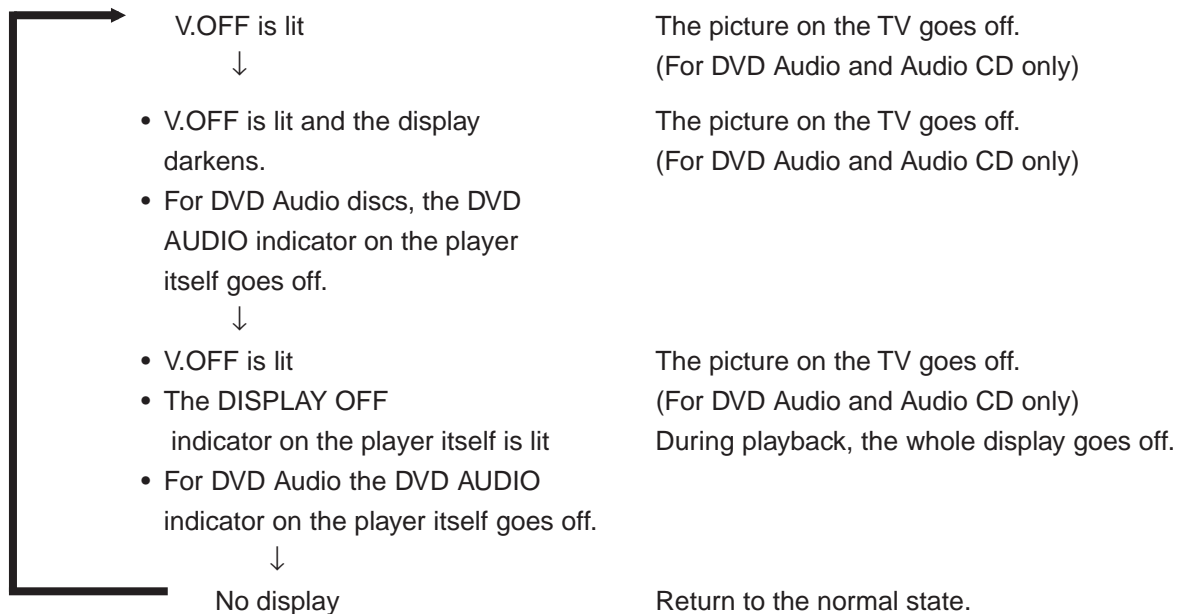

Note:

- For some DVD Audio discs, you may not be able to switch off the picture display.
- You can still access the Initial Settings screen even when the picture display has been switched off.
- If the power is switched off, the settings return to the normal state.

Adjusting the Image Brightness [THEATER POSITION]

You can adjust the image brightness so it best suits the lighting in the room where the video is being played.

- You can perform these operations from the remote control.
- For DVD Audio discs, you can only adjust the image brightness if the disc includes video images. For discs that only include still pictures, or do not include any pictures,  is displayed.

■ While a disc is playing

1 Press [THEATER POSITION] to select the image brightness.

The THEATER POSITION display appears.

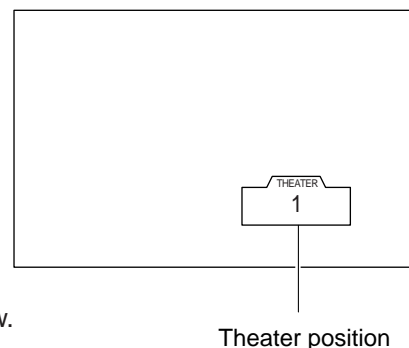

Each press of the button changes the THEATER POSITION as shown below.

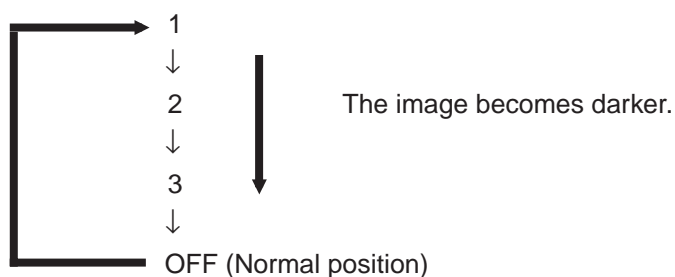

2 Press [ENTER].

The on screen display goes out.

- If you do not perform any operations for five seconds or more, the display automatically goes out.

fs/RATE Display [fs/RATE]

You can display fs (sampling frequency) and bit rate information while a disc is playing.

- You can perform these operations from the remote control.

■ While a disc is playing

1 Press [fs/RATE].

The fs (sampling frequency) and bit rate information for each audio channel stored on the disc and the number of quantized bits is displayed. Five seconds later the display returns to normal.

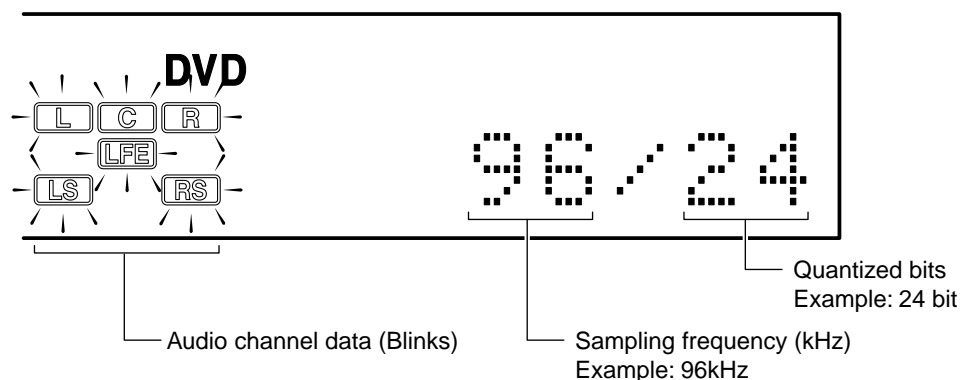

- For DVD Audio discs, a maximum of two audio channels are recorded on the discs. In this case, the data for each channel is displayed as shown below.

Display example: Channel group 1

Example: Front L/R
96kHz/24 bit

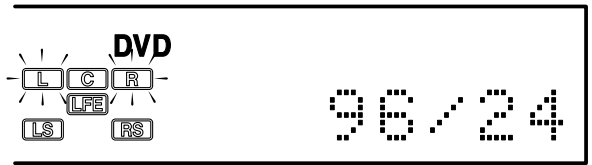

↓ Five seconds later

Channel group 2

Example: Center, Rear L/R, Subwoofer
48kHz/20 bit

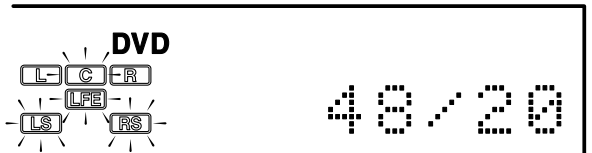

↓ Five seconds later

To original screen

- For DVD Audio/DVD Video discs that use a compressed format, only the fs information is displayed for the audio channels.

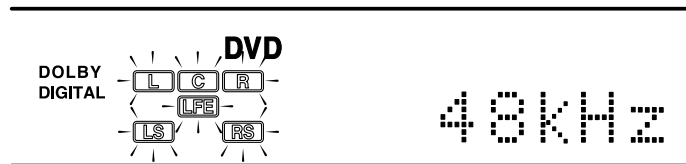

2 Press [fs/RATE] again while the fs information is displayed.

The bit rate/second is displayed. The display is refreshed every 1/2 second.

Example: 9.2Mbps

The bit rate for DVD Audio and DVD Video is variable, so the average bit rate will change depending on the scene. Generally, scenes with a lot of movement will have a higher bit rate.

- Press [fs/RATE] again to return to the original screen.

Changing the Progressive Mode

If you are using a progressive TV or High-Definition TV, set the [PROGRESSIVE] Mode in Initial Settings 2 to a [VIDEO] or [FILM]. See page 28.

When playing film discs, etc., you may achieve better picture quality if the setting is set to Film rather than Video. In this case, you can switch the Progressive mode between [FILM] or [VIDEO] without having to return to the Initial Settings screen.

- The settings are changed as described below.
- You can perform these operations from the remote control.

■ While a disc is playing

1 Press [PLAY MODE].

The current Progressive mode ([VIDEO] or [FILM]) is displayed on screen.

2 Press [PLAY MODE] or ◀▶ to change the Progressive mode setting.

Each press of the button switches the Progressive mode setting between [VIDEO] or [FILM].

3 Press [ENTER].

The on screen display for Progressive mode disappears from the screen.

- If you do not perform any operations for 10 seconds or more, the display automatically goes out.

Note:

- If Progressive mode is set to [OFF], you cannot change the mode. The message "PROGRESSIVE: OFF" will be displayed on screen for two seconds.

Enjoying DVD Audio

This section describes how to use the player to select the song you want to listen to, create a program of songs, repeat a certain song, and various other functions. It also describes the display operations for still images.

- You can perform these operations from the remote control.
- For more information on using the number buttons, see page 19.



● About DVD Audio

DVD Audio discs include tracks that have been divided into groups and can also include still images. The basic structure of DVD Audio discs is shown below.

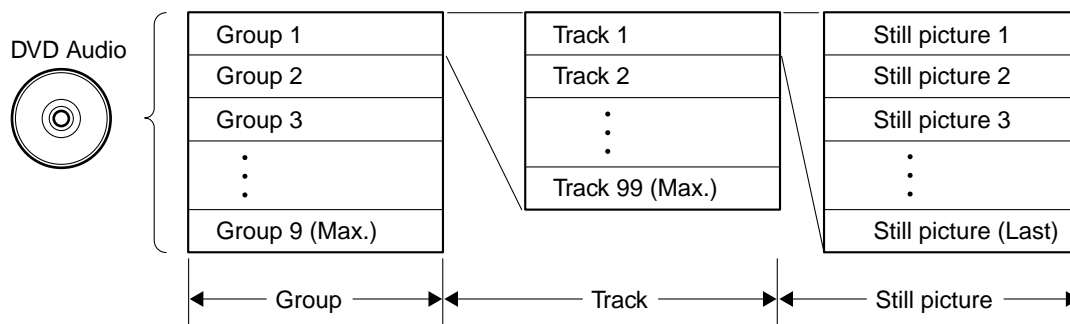

- Up to 9 groups
Some discs also include bonus groups (special groups not listed in the contents.)
BONUS appears on the display.
- One group can contain up to 99 tracks
Some tracks also include index items.
- Multiple still images
Some discs include still images that appear while the disc is playing. These still images can be controlled using the [Automatic Slide Show method] or [Button Operated Browse method]. Some discs also include especial effects for the transition between images.

* The stereo playback of some multi-channel tracks may be prohibited. For these tracks, only the front L/R channel will be output from the digital out. The analog output will be in accordance with the [SPEAKER SETTINGS].

Using the menu to select an item to play

Some DVD Audio discs include a menu screen.

■ Insert a DVD Audio disc

1 Press [TOP MENU].

The menu screen appears.

2 Press ▲/▼/▶/◀ to select an item.

Depending on the menu, you may also be able to use the number keys to select an item.

3 Press [ENTER] or ▷ (Play).

Playback of the selected item begins.

Selecting a Track

● Use the ►►|◄◄ buttons to select a track.

■ While an Audio DVD disc is playing

1 While pressing [GROUP], press ►►| ([GROUP(+)]) or |◄◄ ([GROUP(-)]) to select the group.

►►| (GROUP +): Each time you press the button the group number increases by one.

|◄◄ (GROUP -): Each time you press the button the group number decreases by one.

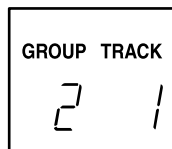

2 Press ►►| or |◄◄ to select the track.

►►| : Each time you press the button the track number within the group increases by one.

|◄◄ : If you press the button once, playback of the track begins. If you press the key again, the track number is reduced by one.

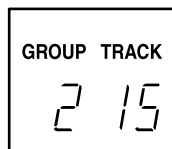

- Playback starts from the selected track.

● Using the number buttons to select a track

■ While an Audio DVD disc is playing

1 While pressing [GROUP], use the number buttons (1-9) to specify the group number.

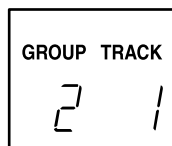

- Playback begins from the first track of the selected group.

2 Press the number buttons to specify the track number.

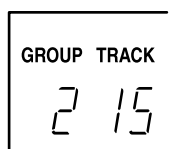

Example: To specify track 15

Press +10 → 5

* : You cannot use the number buttons to specify a track when the menu is displayed.

- Playback of the selected track begins.

Selecting a track from a stopped group

Use the same procedure as described above to select a track.

Selecting an Index Item

If an index has been included with a track, you can specify the index number to begin playback from that index number position.

● Selecting an index item using [CHAP./INDEX] (Index search)

■ While an Audio DVD disc is playing

- 1 While pressing [CHAP./INDEX], use the number buttons to specify the index number.

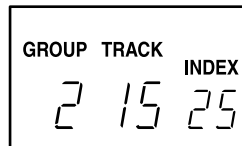

- Playback starts from the selected index number.

● Using the ►►|◄◄ buttons to select an index item (Index skip)

■ While an Audio DVD disc is playing

- 1 While pressing [CHAP./INDEX], press ►►| or ◄◄ to select the index number.

►►| : Each time you press the button the index number increases by one.

◄◄ : Each time you press the button the index number decreases by one.

Still image display operations

Some DVD Audio discs include still images that appear while the disc is playing. You can perform the following still image display operations while B.S.P is on.

Advancing/replaying still images [PAGE +/-]

■ While an Audio DVD disc is playing

- 1 Press [PAGE+] or [PAGE -]

PAGE +: Displays the next still image.

PAGE -: Displays the previous still image.

* B.S.P. appears in red only when the disc includes still images that can be browsed.

Jumping to specified still images on a disc [RETURN]

■ While an Audio DVD disc is playing (Only when B.S.P. is on)

- 1 Press [RETURN].

Jumps to the specified still images on the disc.

- Some discs do not include still images that can be browsed by pressing [RETURN]. In this case, ⓪ is displayed.

Program Playback

You can arrange songs on a disc in the order you want to play them.

- You can include up to 32 songs in a program.

■ While a DVD Audio is stopped

1 Press [PLAY MODE] until PROGRAM is displayed.

Each press of the button changes the display mode as shown below.

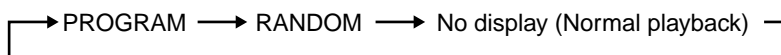

2 Specify the group and track numbers.

- 1) While pressing [GROUP], press the number keys to specify the group number.
- 2) Press the number buttons to select the track number.

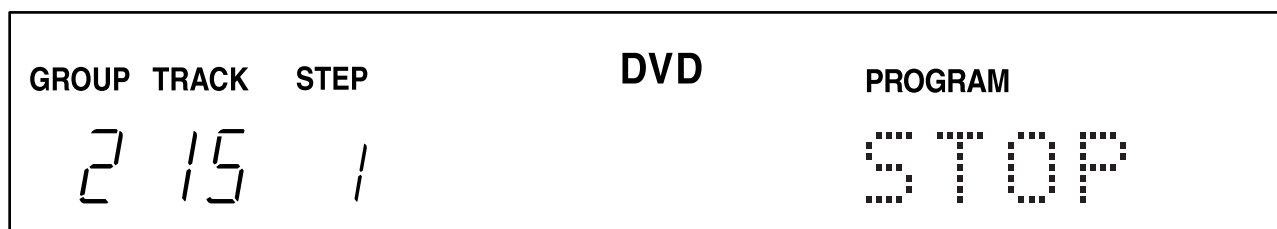

3 Specify the next group and track number.

- If you want to specify another track in the same group, you can skip the step specifying the group.
- You can repeat the same track several times.
- If you make a mistake entering a number, press [CANCEL]. The last track in the program is deleted.

4 When you have finished the programs, press ▷ (Play).

Playback begins using the track order in the program.

- After all tracks in the program have been played, playback stops.
Since the player is still in Program mode, you can continue Program playback.
- Even if you press [PLAY MODE] and select either [NORMAL PLAYBACK] or [RANDOM PLAYBACK], you can still use Program playback after they have finished.
- You can use fast forward/backward or skip through the track, as you would with [NORMAL PLAYBACK].

Checking and editing the contents of a program

Press the ►► button while the disc is stopped. Each press of the button displays the tracks in the program in the order they are programmed. Press ◀◀ to display them in reverse order. The program number currently selected blinks.

- Deleting a program step:
Press [CANCEL]. The selected (blinking) program step is deleted.
- Adding a step to a program:
Repeat the procedure in step 2 and specify the new group and track number. The new program step will be inserted at the currently selected (blinking) program number.
- When you have finished checking the program:
If you press [ENTER], the program step number stops blinking and you return to the last step in the program.

Clearing the contents of a program

- While the disc is stopped, press [CLEAR].
- Open the disc tray or switch the power off.

Random Playback

You can play the songs on a disc in random order. All tracks in all groups on the disc will be played in a random order.

■ While a DVD Audio disc is stopped

1 Press [PLAY MODE] until RANDOM is displayed.

Each press of the button changes the display mode as shown below.

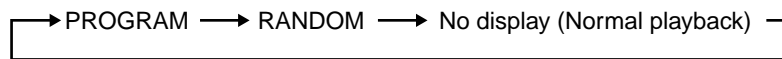

2 Press ▷ (Play).

Random playback begins. All tracks in all groups are played once in a random order, then the playback stops and RANDOM goes out.

Canceling Random Playback

- During playback, press ■ (Stop). Random playback stops and RANDOM goes out.
- While a disc is stopped, press [PLAY MODE]. RANDOM goes out.

Repeat Playback

You can repeat a specified tracks, all tracks in a group, or all tracks in all groups.

■ While an Audio DVD disc is playing or paused

1 Press [REPEAT] to select the repeat mode you want to use.

Each press of the button changes the repeat mode as shown below.

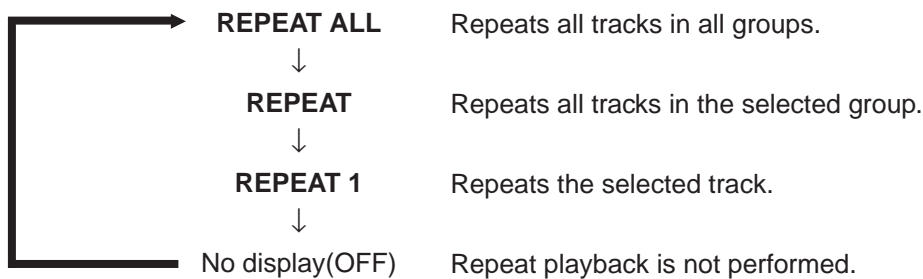

- Repeat playback begins.
- To select repeat playback while a disc is stopped, press ▷ (Play). Repeat playback begins.

Using repeat playback during program playback

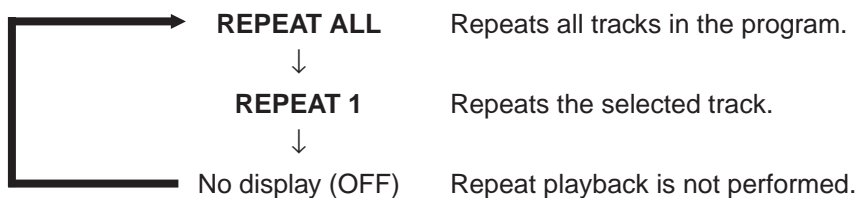

Using repeat playback during random playback

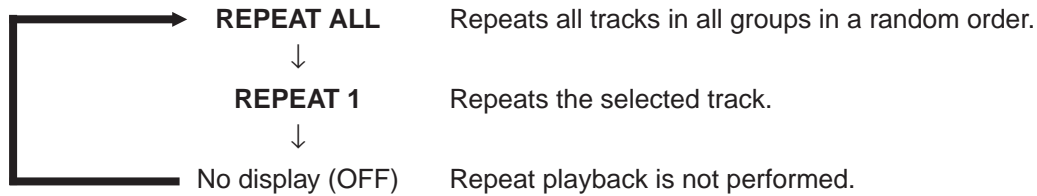

Cancelling Repeat Playback

- Press [REPEAT] to select No display (OFF).
- Repeat playback is also cancelled if you used [PLAY MODE] to change the playback mode.
- It is also cancelled if you open the disc tray or switch the power off.

A-B Repeat Playback

You can repeat a specified section within a single track.

■ While an Audio DVD disc is playing (You cannot select this during program or random playback.)

- 1 Press [REPEAT A-B] at the starting point of the section you want to repeat.
REPEAT A- appears in red, and the A-B Repeat start point (point A) is stored.
- 2 Press [REPEAT A-B] again at the finish point of the section you want to repeat.
REPEAT A-B appears in red, and the A-B Repeat finish point (point B) is stored.
 - Repeat playback of the section between A and B begins.
 - You can also use ►► (Fast forward) to search for point B.

Cancelling A-B Repeat Playback

- You can cancel A-B repeat playback by pressing [REPEAT A-B].
- If you perform an operation that goes beyond point B (skipping ahead to the next track, etc.), A-B repeat playback is cancelled. Or you can press ■ (Stop) to cancel it.
It is also cancelled if you open the disc tray or switch the power off.

Changing the Angle [ANGLE]

Some discs, such as those of live concerts, include video footage taken from several angles (multi-angle) on the same disc. For discs that use this function, you can select the viewing angle you wish to use.

■ While playing a DVD Audio that uses multi-angle

- 1 Press [ANGLE].
- 2 Press [ANGLE], or press ◀▶ to select the camera angle you wish to use.
 - Each press of the button changes the angle.

Example:

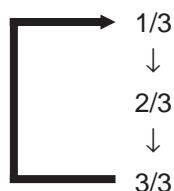

- 3 Press [ENTER].

The Angle on screen display disappears from the TV screen.

- If you do not perform any operations for 10 seconds or more, the display automatically goes out.

If  is displayed when you press a button

The scene being played does not include any multi-angle information.

Changing the Subtitles [SUBTITLE]

When playing a disc that includes subtitles, you can select the type of subtitles, or choose not to display subtitles.

■ **While playing a DVD Audio disc that includes subtitles**

1 Press [SUBTITLE].

2 Press  to select the subtitles.

- Each press of the button changes the subtitles display.

Example:

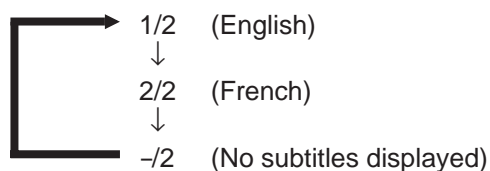

- English, Spanish, French, Chinese, German, Italian, Japanese, and the language codes for any other languages are displayed. See page 68.

3 Press [ENTER].

The Subtitles on screen display disappears from the TV screen.

- If you do not perform any operations for 10 seconds or more, the display automatically goes out.
- You can press [SUBTITLE] to turn the subtitles display on or off.

If  is displayed when you press a button

The disc does not include any subtitles, or prohibits changes being made.

Changing the Audio Setting [AUDIO]

Some DVD Audio discs include multiple audio. For discs that do this, you can select the audio you wish to hear.

■ While playing a DVD Audio that allows multiple audio selection

1 Press [AUDIO].

2 Press [AUDIO], or ◀▶ to select the audio track you wish to hear.

- Each press of the button changes the audio.

Example:



3 Press [ENTER].

The Audio on screen display disappears from the TV screen.

- If you do not perform any operations for 10 seconds or more, the display automatically goes out.

If ⊘ is displayed when you press a button

The disc does not include multiple audio selection, or prohibits changes being made.

- * For DVD Audio only, in addition to the on screen display for audio selection on the TV screen, AUDIO * (*: number) is displayed on the display of the player itself. This means that you can change the audio selection even with the video display switched off.

Playing a Bonus Group

If you insert a disc that includes bonus groups, BONUS appears on the display. You can use the following procedure to play a bonus group.

- In order to playback a bonus group, you need to enter a key number.

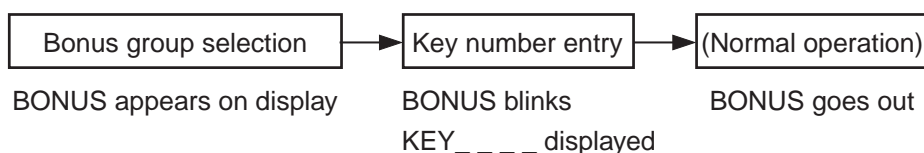

• Selecting a bonus group

If BONUS appears on the display, you can select the bonus group using one of the methods below. When try to select a bonus group, the KEY_ _ _ _ message asking for the key number is displayed.

- The bonus group number will not be displayed until the key number has been entered.

■ While a DVD Audio disc is stopped

- While pressing [GROUP], press the number buttons to select a bonus group.
- Select a bonus group when creating a program.

■ While an Audio DVD disc is playing

- While pressing [GROUP], press ▶▶I (GROUP (+)) to select a bonus group.
- While pressing [GROUP], press the number buttons to select a bonus group.

● Entering the key number

If you select a bonus group using the methods described previously, the following message will appear on the display asking you to enter the key number.

KEY_ _ _ _ (The first digit for the key number blinks)

* About the key number

The key number you enter here is the key number for accessing bonus groups. Please refer to the documentation provided with the disc for details.

■ While an Audio DVD disc is playing or paused

1 Press the number buttons (0-9) to enter the (4 digit) key number.

- To correct a mistake, press ◀/▶ to move to the digit and reenter the number.
- While you are entering the key number BONUS blinks on the display.

2 After entering the (4 digit) key number, press [ENTER] or ▷ (Play).

If the key number is correct, BONUS goes out from the display and the bonus group number is displayed.

You can now perform standard operations with the bonus group.

- If the key number is not correct, the first digit for the key number blinks and the player waits for you to reenter the key number.

Cancelling Key Number Entry Mode

You can exit key number entry mode using one of the following operations.

- Press [CLEAR].
- Switch the power off.
- Not entering the key number within 10 seconds.
- Make a song selection (selecting a group, etc.)
- Press [STOP].

Clearing the key number

- Open the disc tray.

Playing DVD Video Discs

This section describes how to use the player to select titles or chapters, change the camera angle, select the audio or subtitle language, and various other functions.

- You can perform these operations from the remote control.
- For more information on using the number buttons, see page 19.



Selecting the Section You Want to Watch

You can specify a title or chapter to start playback from the section you want to watch.

● Using the menu to select an item to play

Most DVD Video discs, include a menu screen. This menu can include various information, such as the film title or song titles, it can also include information about the artist. You can select the section you want to watch from this menu.

■ Insert a DVD Video disc

1 Press [MENU] or [TOP MENU].

The menu screen appears.

Example:

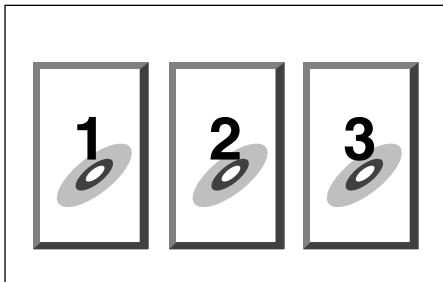

2 Press ◀/▶/▲/▼ to select an item.

- Depending on the menu screen, you can also use the number buttons to make a selection.

3 Press [ENTER] or ▷ (Play).

Playback of the selected item begins.

Using the MENU button and TOP MENU button

If a disc includes several titles, it often includes a menu screen that displays a list of the titles. This type of menu is accessed by pressing the TOP MENU button. On the other hand, even discs that do not include more than one title usually include a menu screen. In this case, the menu is accessed by pressing the MENU button.

For details about the menus for each disc, refer to the documentation provided with the disc.

If ⊗ is displayed when you press a button

- If ⊗ is displayed when you press the TOP MENU button:
The disc does not include a menu that lists the titles on the disc.
- If ⊗ is displayed when you press the MENU button:
The disc does not include any menu screen.

● Specifying the title number to begin playback

Use the number buttons to specify the title number. Playback starts from that number.

■ While a DVD Video disc is stopped

1 Press the number buttons to specify the title number.

The specified title number appears on the display and playback starts from that title number.

- You can also specify this procedure while a disc is playing.

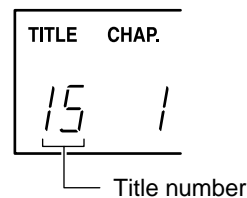

If is displayed when you press a button

The disc does not include the specified title number.

● Specifying the chapter number to begin playback (Chapter search)

For DVD Video discs that include films, the titles are often divided into scenes, or chapters. By specifying these chapter numbers, you can start playback from that scene.

■ While a DVD Video disc is playing

1 While pressing [CHAP./INDEX], press the number keys to specify the chapter number.

Playback begins from the specified chapter.

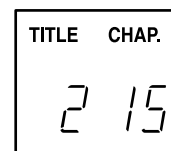

If is displayed when you press a button

The disc does not include a chapter with the specified number, or the disc will not allow you to use this function.

Repeat Playback

You can repeat a title or chapter that is playing.

■ While a DVD Video disc is playing

1 Press [REPEAT] to select the repeat mode you want to use.

Each press of the button changes the repeat mode as shown below.

- Repeat playback begins.

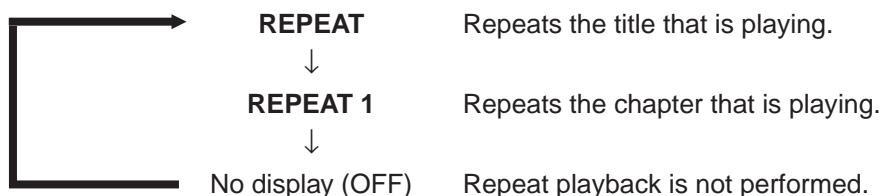

Cancelling Repeat Playback

- Press [REPEAT] to select No display (OFF).
- It is also cancelled if you open the disc tray or switch the power off.

A-B Repeat Playback

You can repeat a specified section you want to watch.

■ While a DVD Video disc is playing

- 1 Press [REPEAT A-B] at the starting point of the section you want to repeat.
REPEAT A- appears in red, and the A-B Repeat start point is stored.
- 2 Press [REPEAT A-B] again at the finish point of the section you want to repeat.
REPEAT A-B appears in red, and the A-B Repeat finish point is stored.
 - Repeat playback of the section between A and B begins.
 - You can also use ►► (Fast forward) to search for point B.

Cancelling A-B Repeat Playback

- You can cancel A-B repeat playback by pressing [REPEAT A-B].
- If you perform an operation that goes beyond point B (skipping ahead to the next chapter, etc.), A-B repeat playback is cancelled. Or you can press ■ (Stop) to cancel it.
It is also cancelled if you open the disc tray or switch the power off.

Changing the Angle [ANGLE]

Some discs, such as those of live concerts, include video footage taken from several angles (multi-angle) on the same disc. For discs that use this function, you can select the viewing angle you wish to use.

■ While playing a DVD Video that uses multi-angle

- 1 Press [ANGLE].
- 2 Press [ANGLE], or press ◀▶ to select the camera angle you wish to use.
 - Each press of the button changes the angle.

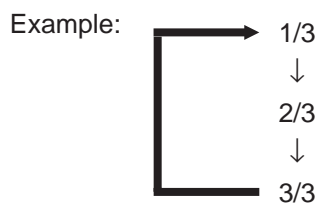

- 3 Press [ENTER].
The Angle on screen display disappears from the TV screen.
 - If you do not perform any operations for 10 seconds or more, the display automatically goes out.

If ⊘ is displayed when you press a button

The scene being played does not include any multi-angle information.

Changing the Subtitles [SUBTITLE]

When playing a disc that includes subtitles, such as foreign language films, you can select the type of subtitles, or choose not to display subtitles.

■ While playing a DVD Video disc that includes subtitles

1 Press [SUBTITLE].

2 Press ◀/▶ to select the subtitles.

- Each press of the button changes the subtitles display.

Example:

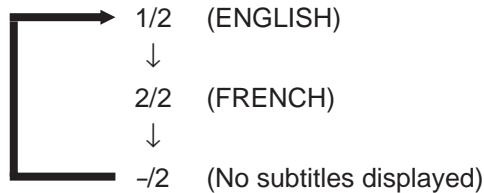

- English, Spanish, French, Chinese, German, Italian, Japanese, and the language codes for any other languages are displayed. See page 68.

3 Press [ENTER].

The Subtitles on screen display disappears from the TV screen.

- If you do not perform any operations for 10 seconds or more, the display automatically goes out.
- You can press [SUBTITLE] to turn the subtitles display on or off.

If ⊘ is displayed when you press a button

The disc does not include any subtitles, or prohibits changes being made.

Changing the Audio Language [AUDIO]

Some discs, such as foreign language films, include audio in more than one language. When playing this type of disc, you can select which audio language to use.

■ While playing a DVD Video that allows multiple audio selection

1 Press [AUDIO].

2 Press [AUDIO], or ◀/▶ to select the audio language you wish to hear.

- Each press of the button changes the audio language.

Example:

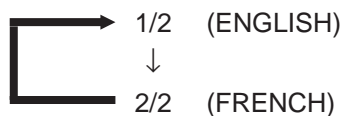

- English, Spanish, French, Chinese, German, Italian, Japanese, and the language codes for any other languages are displayed. See page 68.

3 Press [ENTER].

The Audio on screen display disappears from the TV screen.

- If you do not perform any operations for 10 seconds or more, the display automatically goes out.

If ⊘ is displayed when you press a button

The disc does not include multiple audio languages, or prohibits changes being made.

Parental Lock Setting

Parental lock is a function that allows playback levels for audio or video material to be set depending on the audience. For example, you can use parental lock to cut graphic scenes from films, or replace them with other scenes that you do not want children to watch.

Setting Parental Lock [■+ENTER]

■ While a DVD Video disc is stopped, or no disc is loaded

1 While pressing ■ (Stop), press [ENTER].

The parental lock screen display appears on the TV screen.

2 Press ▲/▼ to align the arrow (↔) with [Country Code], then press ◀/▶ to select a code.

- Normally, you should select US (English.)

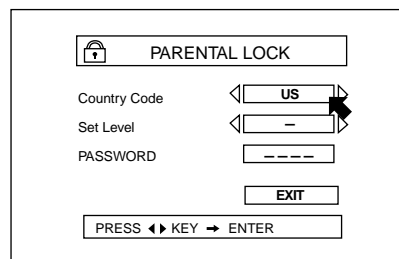

3 Press ▲/▼ to align the arrow (↔) with [Set Level], then press ◀/▶ to select the restriction level.

Each press of the button changes the level from 1 (Most restriction) to 8, and “-” (No restriction).

- For example, if “-” is selected the disc can be played with no restrictions.

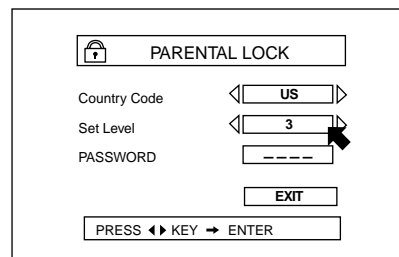

4 Press [ENTER].

The arrow (↔) moves to [PASSWORD].

5 Press the number buttons to enter the password, then press [ENTER].

The parental lock setting and password are set, and the arrow (↔) moves EXIT.

- The password is four digits comprising of the numbers 0-9.
- If you want to reenter the four digit password, enter a new four digit password before pressing [ENTER].

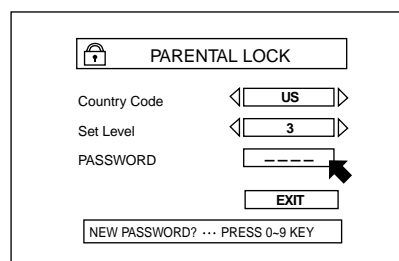

6 Press [ENTER] again.

The display returns to the opening screen.

Changing Parental Lock

The procedure for changing the parental lock settings is similar to the previous procedure, except that you need to enter the existing password before you can make any changes.

■ While a DVD Video disc is stopped or no disc is loaded

1 While pressing ■ (Stop), press [ENTER].

The parental lock screen appears.

- The arrow () moves to [PASSWORD].

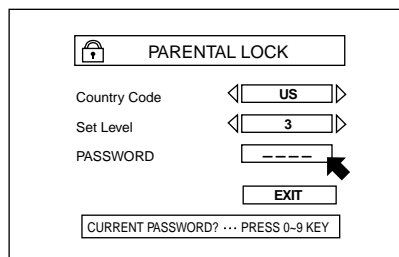

2 Press the number buttons to enter the existing password (four digits), then press [ENTER].

- If the password is not correct, a message asking you to reenter the password will appear. Enter the correct password.

3 Press ▲/▼ to align the arrow () with [Set Level], then press ◀/▶ to select the new restriction level.

- Setting Level 1 : Most restriction
- Setting Level – : No restriction

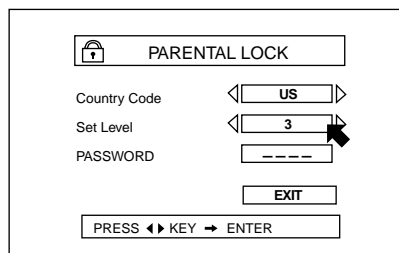

4 Press [ENTER].

The arrow () moves to [PASSWORD].

5 Press the number buttons to enter the new password, then press [ENTER].

The new parental lock setting and password are set, and the arrow () moves EXIT.

6 Press [ENTER] again.

The display returns to the opening screen.

Note:

- If you cannot remember the password for step 2, enter 8888.
- If you enter an incorrect password three times at step 2, the arrow () moves to EXIT and you cannot use the ▲/▼ buttons to move it.

Temporarily Cancelling Parental Lock

If you have set very strict restrictions for the parental lock settings, you may find that you cannot watch discs you want to watch when you try to play them. If this occurs, a screen appears asking if you want to temporarily cancel the parental lock restriction.

■ While the Parental Lock Temporary Cancellation screen is displayed

- 1 Press ▲/▼ to align the arrow () with [YES] or [NO], then press [ENTER].

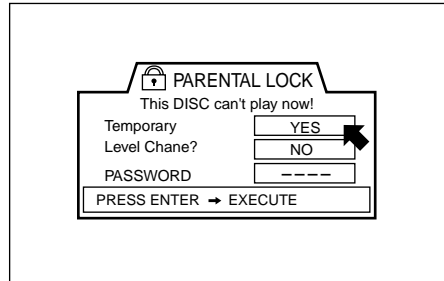

If you select [YES], the arrow () moves to [PASSWORD]. Proceed to step 2.

If you select [NO], press **[OPEN/CLOSE]** to eject the disc.

- 2 Press the number buttons to enter the password (four digits), then press [ENTER].

Parental lock is temporarily cancelled and playback begins.

- If the password is not correct, a message asking you to reenter the password will appear. Enter the correct password.

Note:

- If you enter an incorrect password three times, the arrow () moves to [NO] and you cannot use the ▲/▼ buttons to move it. Press **[OPEN/CLOSE]** to eject the disc.

Playing Audio CD and Video CD Discs

In addition to DVD discs, this player can play Audio CD and Video CD discs. For Video CD discs that include PBC (Playback Control), you can use a menu screen to select items, the operations for both types of CD is similar. This section describes the operation for both types of CD.



- You can perform these operations from the remote control.
- For more information on using the number buttons, see page 19.

● About Video CDs with PBC (Playback Control)

- Most Video CD discs include the PBC function. When you insert these Video CD discs, PBC appears in the display on the player and a menu appears on the TV screen. You can select songs to playback from this menu.
- You can also play Video CD discs without using the PBC function. While the disc is stopped, if you press the number buttons to start playback, PBC is not displayed and the songs are played in the same way as Audio CD discs.
- Video CD discs that do not include the PBC function are played in the same way as Audio CD discs.

These points are summarized in the table below.

Video CD PBC Functions

PBC Function		Basic operations	PBC display
With PBC function	Playback with PBC On (Menu playback)	<p>Select songs from the menu screen using the number buttons, while PBC is displayed.</p> <ul style="list-style-type: none"> • While a disc is playing, basic operation are the same as those for Audio CD discs. <p>PBC changes as follows.</p> <ul style="list-style-type: none"> • Use ►►/ /◀◀ to change operations while a disc is stopped ►► : PBC →1 →2 →●●● ◀◀ : ●●●→2 →1 →PBC • PBC playback only while PBC is displayed. <p>For example, if you display and play track 3, playback will begin from track 3 with PBC off.</p>	○
	Playback with PBC Off (Playback without using menu)	<p>While a Video CD is stopped, specify the track (song) to play using the number buttons. (To start playback from the beginning of the disc, press 1.)</p> <ul style="list-style-type: none"> • While a disc is playing, basic operation are the same as those for Audio CD discs. 	—
Without PBC function		<ul style="list-style-type: none"> • Same operations as for Audio CD discs 	—

Note:

- When using the PBC menu, you cannot use the cursor or ENTER buttons.

Selecting a Song from a Menu

When you play a Video CD disc that includes PBC, PBC appears on the display of the player and the contents of the menu included on the disc are displayed on the TV screen. You can use this menu to jump directly to the item you want to watch.

■ While the PBC menu is displayed on the screen

1 Press the number buttons to select a song.

Example:

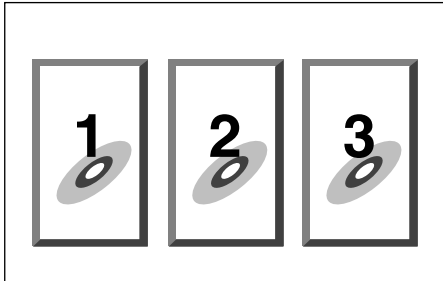

Playback of the selected song begins.

To return to the menu screen, press [RETURN].

If [Next] or [Previous] are displayed on the menu screen.

- Press the ►► button to advance to the next page of the menu.
- Press the ◀◀ button to return to the previous page of the menu.
- * The operation procedure can vary depending on the disc.

Selecting a Track

■ While an Audio CD or Video CD is stopped or playing

1 Press the number buttons to specify the track number.

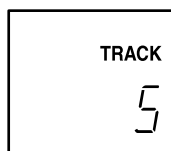

- Playback begins from the specified track number.

When using Video CD discs

- If you specify a track number while a disc is stopped, playback begins with PBC off (playback without using the menu.)
- Even when playing a disc with PBC on, some discs will not allow you to specify a track number while the disc is playing.

Selecting an Index Item

If an Audio CD disc includes an index with a track, you can specify the index number to begin playback from that index number position.

● Selecting an index item using [CHAP./INDEX] (Index search)

■ While an Audio CD disc is playing

1 While pressing [CHAP./INDEX], use the number buttons to specify the index number.

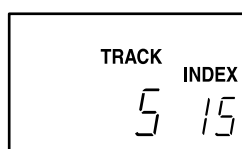

- Playback starts from the selected index number.

● **Using the ►►/◄◄ buttons to select an index item (Index skip)**

■ **While an Audio CD disc is playing**

1 While pressing [CHAP./INDEX], press ►► or ◄◄ to select the index number.

►► : Each time you press the button the index number increases by 1.

◄◄ : Each time you press the button the index number decreases by 1.

Program Playback  

You can arrange songs on a disc in the order you want to play them.

- You can include up to 32 songs in a program.

■ **While an Audio CD or Video CD disc is stopped**

1 Press [PLAY MODE] until PROGRAM is displayed.

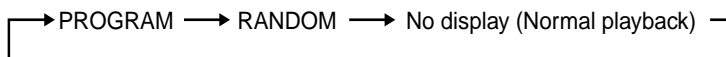

Each press of the button changes the display mode as shown below.

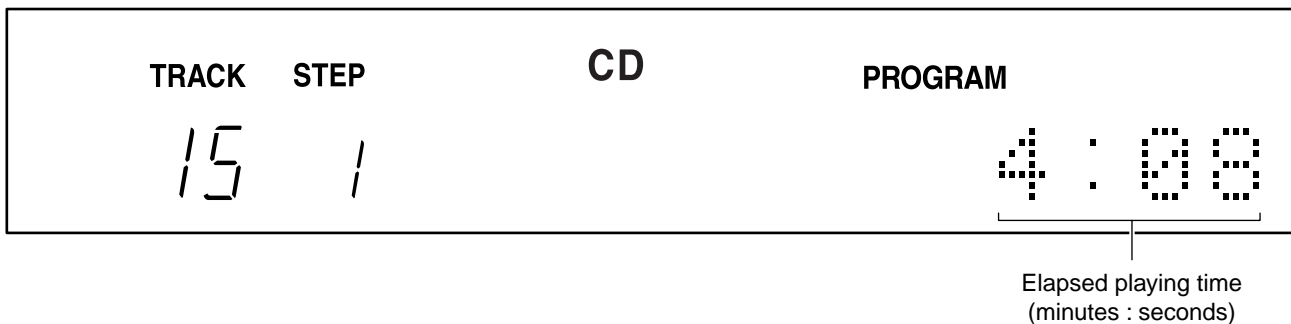

2 Press the number buttons to select the track number.

3 Specify the next track number.

- You can repeat the same track several times.
- If you make a mistake entering a number, press [CANCEL]. The last track in the program is deleted.

4 When you have finished the programs, press ▷ (Play).

Playback begins using the track order in the program.

- After all the tracks in the program have been played, playback stops. Since the player is still in Program mode, you can continue Program playback.
- Even if you press [PLAY MODE] and select either [NORMAL PLAYBACK] or [RANDOM PLAYBACK], you can still use Program playback after they have finished.
- You can use fast forward/backward or skip through the track, as you would with [NORMAL PLAYBACK].

Checking and editing the contents of a program

Press the ►► button while the disc is stopped. Each press of the button displays the tracks in the program in the order they are programmed. Press ◄◄ to display them in reverse order.

The program number currently selected blinks.

- Deleting a program step:
Press [CANCEL]. The selected (blinking) program step is deleted.
- Adding a step to a program:
Repeat the procedure in step 2 and specify the new track number. The new program step will be inserted at the currently selected (blinking) program number.

- When you have finished checking the program:
If you press [ENTER], the program step number stops blinking you return to the last step in the program.

Clearing the contents of a program

- While the disc is stopped, press [CLEAR].
- Open the disc tray or switch the power off.

Random Playback

You can play the songs on a disc in random order. All tracks on the disc will be played in a random order.

■ While an Audio CD or Video CD disc is stopped

1 Press [PLAY MODE] until RANDOM is displayed.

Each press of the button changes the display mode as shown below.

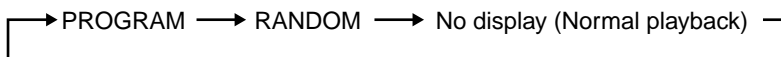

2 Press ▷ (Play).

Random playback begins. All tracks are played once in a random order, then playback stops and RANDOM goes out.

Cancelling Random Playback

- During playback, press ■ (Stop). Random playback stops and RANDOM goes out.
- While a disc is stopped, press [PLAY MODE]. RANDOM goes out.

Repeat Playback

You can repeat a specified track or all tracks on a disc.

You cannot use repeat playback while playing a Video CD disc using PBC.

■ While an Audio CD or Video CD is playing or stopped

1 Press [REPEAT] to select the repeat mode you want to use.



Each press of the button changes the repeat mode as shown below.

- Repeat playback begins.
- To select repeat playback while a disc is stopped, press ▷ (Play). Repeat playback begins.

Using repeat playback during program playback

- REPEAT : Repeats all the tracks in the program.
- REPEAT 1 : Repeats the selected track.
- No display (OFF) : Repeat playback is not performed.

Using repeat playback during random playback

REPEAT : Repeats all tracks in a random order.

REPEAT 1 : Repeats the selected track.

No display (OFF) : Repeat playback is not performed.

Cancelling Repeat Playback

- Press [REPEAT] to select No display (OFF).
- Repeat playback is also cancelled if you used [PLAY MODE] to change the playback mode.
- It is also cancelled if you open the disc tray or switch the power off.

A-B Repeat Playback

You can repeat a specified section within a single track.

■ While an Audio CD or Video CD is playing (You cannot select this during program or random playback.)

1 Press [REPEAT A-B] at the starting point of the section you want to repeat.

REPEAT A- appears in red, and the A-B Repeat start point is stored.

2 Press [REPEAT A-B] again at the finish point of the section you want to repeat.

REPEAT A-B appears in red, and the A-B Repeat finish point is stored.

- Repeat playback of the section between A and B begins.
- You can also use ►► (Fast forward) to search for point B.

Cancelling A-B Repeat Playback

- You can cancel A-B repeat playback by pressing [REPEAT A-B].
- If you perform an operation that goes beyond point B (skipping ahead to the next track, etc.), A-B repeat playback is cancelled. Or you can press ■ (Stop) to cancel it.
It is also cancelled if you open the disc tray or switch the power off.
- If you exit the track, the A point is cancelled. (You only perform A-B Repeat within a single track.)

Changing the Audio Channel [AUDIO]

Some Video CD discs, such as Karaoke discs, include several audio channels: one channel with a vocal track and one channel without a vocal track. When playing these types of discs, you can select the channel with vocals or without vocals.

■ While a Video CD disc is playing

1 Press [AUDIO].

The audio channels (L/R, L, or R) are displayed on the TV screen.

2 Press ◀/▶ to switch between the channels.

You can choose between the following three settings.

- L/R : Normal stereo playback.
- L : Outputs the L (Left) channel to the left and right speakers.
- R : Outputs the R (Right) channel to the left and right speakers.

Extended K2 Processing

Version 2.0 Function

This section describes the Extended K2 Processing Version 2.0 function and how to use it.



Basic Outline

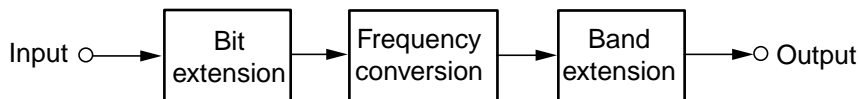

Input	Output
44.1kHz, 16/20/24 bit	176.4kHz, 24 bit
48kHz, 16/20/24 bit	192kHz, 24 bit
88.2kHz, 16/20/24 bit	176.4kHz, 24 bit
96kHz, 16/20/24 bit	192kHz, 24 bit

Bit Extension and Frequency/Band Expansion

The Extended K2 Processing Version 2.0 technology is a new process that performs bit extension and band expansion for the digital signal from CD and DVD discs to provide a sound quality that is closer to original sound. The process can be divided into three parts, Bit expansion, Frequency conversion, and Band expansion, with each enhancement applying supposition of the analog signal before conversion to a digital signal, and then quantization as a new high bit, high sampling digital signal. This allows it to convert the audio from normal CD format or various DVD formats to a maximum output of 24 bits and the frequency band by a maximum of four times for a high quality, high bit, high sampling format.

How to Use the Extended K2 Processing Version 2.0, Function

- To use the Extended K2 Processing version 2.0, press [EX K2] on the remote control or [EXTENDED K2 PROCESSING] on the player itself.
 - The EXTENDED K2 PROCESSING indicator on the player comes on and the Extended K2 Processing Version 2.0, function is enabled.

The Extended K2 Processing Version 2.0, function effects the front L/R channels for the following discs.

- Audio CD, Video CD
- DVD Audio, DVD Video

(The function does not work for disc with a sampling frequencies of 176.4kHz, or 192kHz.)

Notice

- You cannot out put the signal that has been processed by the Extended K2 Processing to the digital output (AUDIO DIGITAL OUTPUT) terminals.

Handling Discs

Handling precautions

When handling discs, be sure to observe the following precautions. If you do not handle discs properly, it can become difficult to read the signal from them, noise may be generated by the disc, or cause other malfunctions.

- When removing the disc from its case, lift the disc out while holding the pressing the center of the case.
- Be careful not to damage the disc.
- Keep the signal surface (rear surface) of the disc clean, do not stick labels or sticky tape on the label surface of the disc.
- Do not bend or warp the disc.

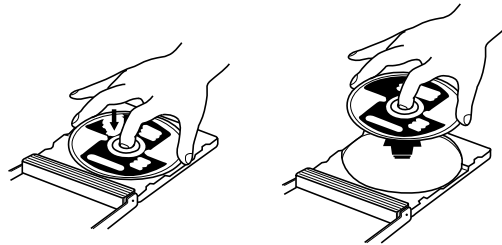

Storing discs

Always store discs in their cases to prevent dust, scratches or warping, and avoid storing them in the following locations.

- Locations exposed to direct sunlight
- Locations with high levels of humidity or dust
- Locations exposed to high temperatures, such as near heaters or in a car

Cleaning discs

- If dust or fingerprints appear on the signal surface of the discs, wipe them gently with a soft, dry cloth from the center of the disc to the edge. Do not wipe the disc along the circumference.
- Never use record cleaner, record spray, thinner, benzine, or other solvents to clean the discs.

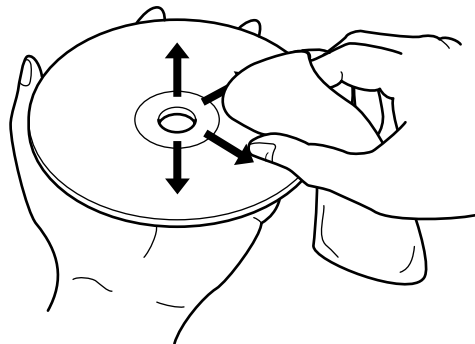

Troubleshooting

If you experience problems with your player, please check the table below before calling for service.

Problem	Cause	Solution
The power does not come on.	The power cord is not plugged into the socket.	Insert the power plug firmly.
The remote control does not work.	The player is too far away. The remote control is not pointing towards the player.	Try to make sure that there are no obstructions within 5 m of the remote control optical sensor.
	The batteries have died.	Replace the batteries.
	The polarity (+/-) of the batteries is incorrect.	Insert the batteries correctly.
	Sunlight is shining on the remote control optical sensor.	Cut off the sunlight.
There is no video.	The video cable is not connected correctly.	Connect the cables correctly. See page 8 and 9.
	The input selection on the TV is incorrect.	Make sure the selection is correct.
	The Video Off function is on. (V.OFF displayed)	Cancel Video Off. See page 38.
There is no sound.	The cables are not connected correctly.	Connect the cables correctly. See pages 8 to 12.
	The input selection on the amplifier is incorrect.	Make sure connections/operations are correct.
There is no sound. NO AUDIO is displayed.	The disc has been illegally copied.	Consult with disc vendor.
MULTI CH is displayed. L/R ONLY is displayed.	The track is prohibited STEREO PLAYBACK.	Listen in MULTI CHANNEL SETTING or listen another STEREO track.
You cannot play a disc.	The disc is not an NTSC disc. The regional code (locale lock) of the player and the disc do not match.	Replace the disc.
	The disc is a type the player cannot play, such as CD-R, etc.	
The picture is jittery.	The disc is dirty.	Clean the disc.
	A video recorder is connected between the player and the TV.	Connect the player directly to the TV.
	Progressive mode is On, for a TV that does not support progressive output.	Turn off Progressive mode. See page 28.
The picture is stretched vertically or horizontally.	The initial settings are incorrect.	Set the initial settings to match the TV type. See page 26.
	The TV settings are incorrect.	Correct the TV settings.
The player does not operate correctly.	Lightning or electrical noise has damaged the circuitry.	Turn off the power, then reconnect the power cord.
	Condensation has formed inside the player because a heater has just been turned on or the player has been moved from a cold to a warm location.	Turn off the power, then turn the power back on a few hours later.

If these items do not apply, the problem may not be with the player. Check any other equipment connected to the player. If you still cannot solve the problem after checking the items above, refer to the Warranty, on page 73, and call for service.

Specifications

● General

Supported disc types	:	DVD Audio, DVD Video, Video CD, Audio CD
Video standard	:	NTSC color TV format
Power supply	:	AC120V~60Hz
Power consumption	:	At power on 35 W During standby (STANDBY) 2 W
Weight	:	13.1 kg (29.5 lbs)
External dimensions	:	(W) 436 mm x (H) 125 mm x (D) 391 mm 17 ^{-3/16} x 4 ^{-15/16} x 15 ^{-7/16} inches
Accessories	:	Power cord x1 Remote control x1

● Video output

Video	:	1.0 Vp- p/75 Ω
S-Video	:	Y output : 1.0 Vp- p/75 Ω C output : 0.286 Vp- p/75 Ω
Video (Component)	:	Y output : 1.0 Vp- p/75 Ω P _B /P _R output : 0.7 Vp- p/75 Ω
Horizontal resolution	:	Over 500 lines
S/N ratio	:	Over 73 dB

● Audio output

Analog audio output	:	2.5 V _{rms} /10 k Ω
Digital audio output	:	Optical : -21 dBm to -15 dBm (Peak) Coaxial : 0.5 Vp- p/75 Ω

● Audio characteristics

Frequency characteristics	:	CD (fs =44.1 kHz) : 2 Hz to 20 kHz DVD Audio/Video (fs =48 kHz) : 2 Hz to 22 kHz DVD Audio/Video(fs =96 kHz) : 2 Hz to 44 kHz DVD Audio(fs =192 kHz) : 2 Hz to 88 kHz * fs : Sampling frequency
Dynamic range	:	16 bit : Over 100 dB 20 bit/24 bit : Over 112 dB
Overall high wave modulation ratio	:	16 bit : Less than 0.0015 % 20 bit/24 bit : Less than 0.0010 %
Wow/Flutter	:	Less than measurement limit (± 0.001 % W.PEAK)

- The specifications and appearance of this model are subject to change without notice.

Dimensions

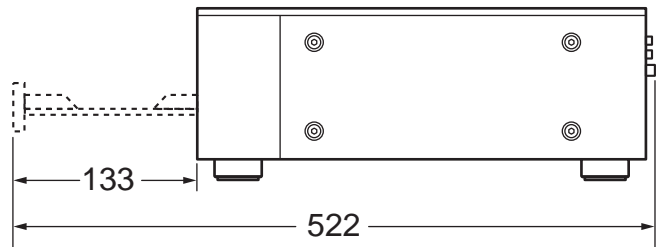
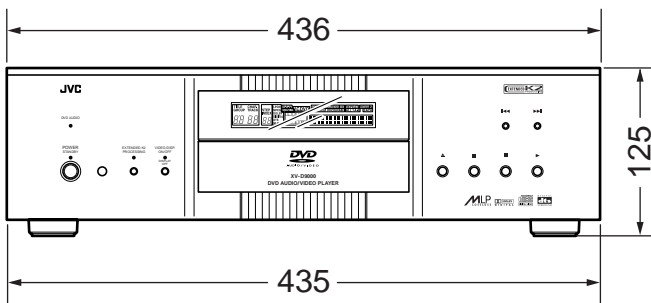
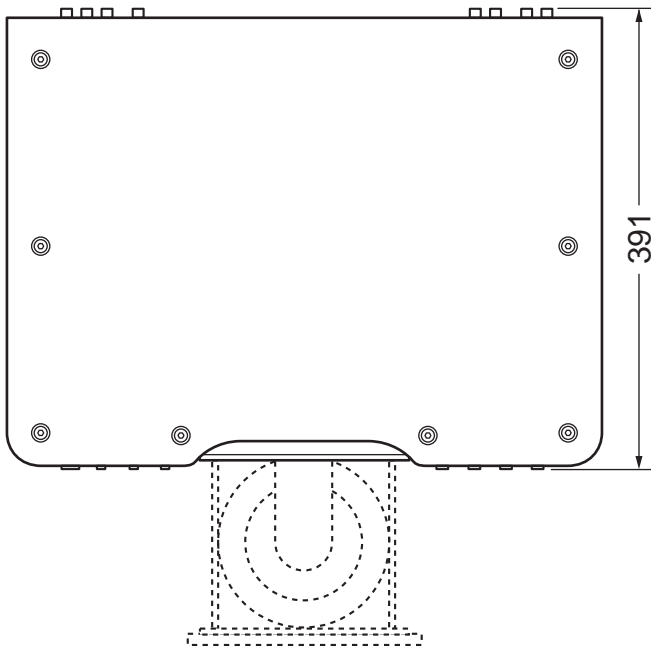

(Units: mm)

Table of Languages and Their Abbreviations

When you select the subtitle language or sound, the languages shown below are displayed as abbreviations. To select the desired language, select the abbreviation corresponding the language you want to.

AA	Afar
AB	Abkhazian
AF	Afrikaans
AM	Ameharic
AR	Arabic
AS	Assamese
AY	Aymara
AZ	Azerbaijani
BA	Bashkir
BE	Byelorussian
BG	Bulgarian
BH	Bihari
BI	Bislama
BN	Bengali, Bangla
BO	Tibetan
BR	Breton
CA	Catalan
CO	Corsican
CS	Czech
CY	Welsh
DA	Danish
DZ	Bhutani
EL	Greek
EO	Esperanto
ET	Estonian
EU	Basque
FA	Persian
FI	Finnish
FJ	Fiji
FO	Faroese
FY	Frisian
GA	Irish
GD	Scots Gaelic
GL	Galician
GN	Guarani
GU	Gujarati
HA	Hausa
HI	Hindi
HR	Croatian
HU	Hungarian
HY	Armenian
IA	Interlingua
IE	Interlingue

IK	Inupiak
IN	Indonesian
IS	Icelandic
IW	Hebrew
JI	Yiddish
JW	Javanese
KA	Georgian
KK	Kazakh
KL	Greenlandic
KM	Cambodian
KN	Kannada
KO	Korean (KOR)
KS	Kashmiri
KU	Kurdish
KY	Kirghiz
LA	Latin
LN	Lingala
LO	Laothian
LT	Lithuanian
LV	Latvian, Lettish
MG	Malagasy
MI	Maori
MK	Macedonian
ML	Malayalam
MN	Mongolian
MO	Moldavian
MR	Marathi
MS	Malay (MAY)
MT	Maltese
MY	Burmese
NA	Nauru
NE	Nepali
NL	Dutch
NO	Norwegian
OC	Occitan
OM	(Afan) Oromo
OR	Oriya
PA	Panjabi
PL	Polish
PS	Pashto, Pushto
PT	Portuguese
QU	Quechua
RM	Rhaeto-Romance

RN	Kirundi
RO	Rumanian
RU	Russian
RW	Kinyarwanda
SA	Sanskrit
SD	Sindhi
SG	Sangho
SH	Serbo-Croatian
SI	Singhalese
SK	Slovak
SL	Slovenian
SM	Samoan
SN	Shona
SO	Somali
SQ	Albanian
SR	Serbian
SS	Siswati
ST	Sesotho
SU	Sundanese
SV	Swedish
SW	Swahili
TA	Tami l
TE	Telugu
TG	Tajik
TH	Thai
TI	Tigrinya
TK	Turkmen
TL	Tagalog
TN	Setswana
TO	Tonga
TR	Turkish
TS	Tsonga
TT	Tatar
TW	Twi
UK	Ukrainian
UR	Urdu
UZ	Uzbek
VI	Vietnamese
VO	Volapuk
WO	Wolof
XH	Xhosa
YO	Yoruba
ZU	Zulu

Country Code List for Parental Lock

This list is used for the Parental Lock operation. For details, see page 55.

AD	Andorra
AE	United Arab Emirates
AF	Afghanistan
AG	Antigua and Barbuda
AI	Anguilla
AL	Albania
AM	Armenia
AN	Netherlands Antilles
AO	Angola
AQ	Antarctica
AR	Argentina
AS	American Samoa
AT	Austria
AU	Australia
AW	Aruba
AZ	Azerbaijan
BA	Bosnia and Herzegovina
BB	Barbados
BD	Bangladesh
BE	Belgium
BF	Burkina Faso
BG	Bulgaria
BH	Bahrain
BI	Burundi
BJ	Benin
BM	Bermuda
BN	Brunei Darussalam
BO	Bolivia
BR	Brazil
BS	Bahamas
BT	Bhutan
BV	Bouvet Island
BW	Botswana
BY	Belarus
BZ	Belize
CA	Canada
CC	Cocos (Keeling) Islands
CF	Central African Republic
CG	Congo
CH	Switzerland
CI	Cote d'Ivoire
CK	Cook Islands
CL	Chile
CM	Cameroon
CN	China
CO	Colombia
CR	Costa Rica
CU	Cuba
CV	Cape Verde
CX	Christmas Island
CY	Cyprus
CZ	Czech Republic
DE	Germany
DJ	Djibouti
DK	Denmark
DM	Dominica
DO	Dominican Republic
DZ	Algeria
EC	Ecuador
EE	Estonia
EG	Egypt
EH	Western Sahara
ER	Eritrea

ES	Spain
ET	Ethiopia
FI	Finland
FJ	Fiji
FK	Falkland Islands(Malvinas)
FM	Micronesia (Federated States of)
FO	Faroe Islands
FR	France
FX	France, Metropolitan
GA	Gabon
GB	United Kingdom
GD	Grenada
GE	Georgia
GF	French Guiana
GH	Ghana
GI	Gibraltar
GL	Greenland
GM	Gambia
GN	Guinea
GP	Guadeloupe
GQ	Equatorial Guinea
GR	Greece
GS	South Georgia and the South Sandwich Islands
GT	Guatemala
GU	Guam
GW	Guinea-Bissau
GY	Guyana
HK	Hong Kong
HM	Heard Island and McDonald Islands
HN	Honduras
HR	Croatia
HT	Haiti
HU	Hungary
ID	Indonesia
IE	Ireland
IL	Israel
IN	India
IO	British Indian Ocean Territory
IQ	Iraq
IR	Iran (Islamic Republic of)
IS	Iceland
IT	Italy
JM	Jamaica
JO	Jordan
JP	Japan
KE	Kenya
KG	Kyrgyzstan
KH	Cambodia
KI	Kiribati
KM	Comoros
KN	Saint Kitts and Nevis
KP	Korea, Democratic People's Republic of
KR	Korea, Republic of
KW	Kuwait
KY	Cayman Islands
KZ	Kazakhstan
LA	Lao People's Democratic Republic

LB	Lebanon
LC	Saint Lucia
LI	Liechtenstein
LK	Sri Lanka
LR	Liberia
LS	Lesotho
LT	Lithuania
LU	Luxembourg
LV	Latvia
LY	Libyan Arab Jamahiriya
MA	Morocco
MC	Monaco
MD	Moldova, Republic of
MG	Madagascar
MH	Marshall Islands
ML	Mali
MM	Myanmar
MN	Mongolia
MO	Macau
MP	Northern Mariana Islands
MQ	Martinique
MR	Mauritania
MS	Montserrat
MT	Malta
MU	Mauritius
MV	Maldives
MW	Malawi
MX	Mexico
MY	Malaysia
MZ	Mozambique
NA	Namibia
NC	New Caledonia
NE	Niger
NF	Norfolk Island
NG	Nigeria
NI	Nicaragua
NL	Netherlands
NO	Norway
NP	Nepal
NR	Nauru
NU	Niue
NZ	New Zealand
OM	Oman
PA	Panama
PE	Peru
PF	French Polynesia
PG	Papua New Guinea
PH	Philippines
PK	Pakistan
PL	Poland
PM	Saint Pierre and Miquelon
PN	Pitcairn
PR	Puerto Rico
PT	Portugal
PW	Palau
PY	Paraguay
QA	Qatar
RE	Reunion
RO	Romania
RU	Russian Federation
RW	Rwanda

SA	Saudi Arabia
SB	Solomon Islands
SC	Seychelles
SD	Sudan
SE	Sweden
SG	Singapore
SH	Saint Helena
SI	Slovenia
SJ	Svalbard and Jan Mayen
SK	Slovakia
SL	Sierra Leone
SM	San Marino
SN	Senegal
SO	Somalia
SR	Suriname
ST	Sao Tome and Principe
SV	El Salvador
SY	Syrian Arab Republic
SZ	Swaziland
TC	Turks and Caicos Islands
TD	Chad
TF	French Southern Territories
TG	Togo
TH	Thailand
TJ	Tajikistan
TK	Tokelau
TM	Turkmenistan
TN	Tunisia
TO	Tonga
TP	East Timor
TR	Turkey
TT	Trinidad and Tobago
TV	Tuvalu
TW	Taiwan, Province of China
TZ	Tanzania, United Republic of
UA	Ukraine
UG	Uganda
UM	United States Minor Outlying Islands
US	United States
UY	Uruguay
UZ	Uzbekistan
VA	Vatican City State (Holy See)
VC	Saint Vincent and the Grenadines
VE	Venezuela
VG	Virgin Islands (British)
VI	Virgin Islands (U.S.)
VN	Vietnam
VU	Vanuatu
WF	Wallis and Futuna Islands
WS	Samoa
YE	Yemen
YT	Mayotte
YU	Yugoslavia
ZA	South Africa
ZM	Zambia
ZR	Zaire
ZW	Zimbabwe

Glossary

A

Aspect ratio

The horizontal to vertical ratio of the displayed image. For standard TV's the horizontal/vertical ratio is 4:3, for wide-screen TV's the horizontal/vertical ratio is 16:9.

Authoring

The process of encoding the source material, or the process of adding control information to the encoded data, or converting the data to DVD format.

B

Bit rate

The transfer rate.

Bit stream

The digital data generated by the various encoding processes.

C

Chapter

Each chapter within a title.

Color variation signal

A signal that removes the brightness signal from the G/B/R signals and represents the hue and density.

Component

A video format that takes three separate video inputs with information for the three primary colors of light to create the video signal. There are G/B/R, Y/P_B/P_R and other formats.

Composite

A synchronous composite video signal that combines a signal combining the brightness and color frequency signals and a standard color burst signal.

Cursor

Generally, the point where you enter numbers.

D

Decode

The process of decoding a signal that has been encoded in a format standard, so that it restores to the original signal.

Dolby Digital

The Dolby Digital (AC-3) format developed to produce theater-like surround sound for household systems. Consists of a maximum of 5.1 channels, three front channels, two rear channels, and a 0.1 subwoofer channel.

Downmix

This function converts multichannel (three channels or more) sound formats for audio tracks to two stereo channels. This is usually performed when the number of program channels is larger than the number of speakers.

DTS (Digital Theater System)

A new surround format that holds more data than Dolby Digital to provide even better surround playback.

The number of channels is the same 5.1 channel of Dolby Digital but the use of a better audio compression ratio during digital recording means that it has higher S/N playback. It also has a wider dynamic range for delicate sound separation.

E

Encode

The process of encoding a signal to meet a standard.

Extended K2 Processing

20 bit K2 processing extends 16 bit signals to 20 bit to improve signal resolution, and also expands the sampling frequency by two to improve the frequency band during playback. This allows better sound reproduction of the subtle nuances of the original for more realistic sound playback.

Version 2.0 further expands this capability to 24 bit 176.4kHz/192kHz.

G

Geographical region playback control (Regional code)

A system that only allows playback of a disc in predetermined geographical regions. There are eight regions in the world, and each region has a number (Region No.) If the region number on the disc matches the region number assigned to the player, you can play the disc.

L

Letterbox

A technique for displaying wide screen video on a 4:3 TV without clipping the image by projecting a black, or other color, mask across the top and bottom parts of the screen. It is called by this name, since the appearance is similar to a letterbox.

Linear PCM audio

A lossless compression format for converting an analog audio signal to a digital signal.

M**Menu**

A screen included on DVD Video discs that allows you to select the titles of video or audio on the disc, or to select the subtitles or camera angle, etc.

Multi-angle

A function that includes multiple camera angles for the same scene in a title and allows the user to select which angle to use.

Multichannel

For DVD Audio discs, a single audio track can only consist of one sound scene. However, they can include three or more channels for the audio track.

Multilingual

A function that allows a single title to support several languages.

Multi-story

A function that includes multiple story variations for the same title. Usually this allows you to select the story you wish to follow when playing the disc, and to continue making selections via a menu at each story junction within the title.

O**One-sided disc**

DVD discs that include signals that can only be read from one surface. There are single layer and dual layer one-sided discs.

P**Parental control function**

A function that can automatically detect whether the video or audio content of a disc is appropriate for the audience (for example, educationally undesirable scenes) by comparing the parental level stored on the disc with the parental level set on the player. If the levels match, or the level on the player is higher, you can play the disc.

Playback control (PBC)

A signal included on (version 2.0) Video CD discs that can control playback. Video CD discs that support this function include a menu on the disc which allows you to interact with the software, perform searches and other functions.

S**Sampling frequency**

The sampling frequency used when converting the analog signal to a digital signal. Expressed as a rate of times/second, it samples the analog signal and determines the digital signal value.

Squeezed video

A method of storing 16:9 video data that is uniformly shrunk (squeezed) to 4:3 video size.

When this is displayed on a TV or monitor the left and right are stretched so that it returns to the original ratio.

Surround

An audio encoding system that produces realistic, theater-like sound to speakers placed around the listener.

S-Video format

A video signal that separates the brightness signal (Y) and color signal (C) of a traditional video signal. It produces an image with very little color blur.

T**Transfer rate**

The amount of digital data transferred in one second, using a transfer rate capable of MPEG-2 compression.

Two-sided discs

DVD discs that include signals that can be read from both surfaces. The disc needs to be turned over.

QUALITY **JVC** SERVICE

HOW TO LOCATE YOUR JVC SERVICE CENTER

TOLL FREE : 1-800-537-5722

Dear customer:

In order to receive the most satisfaction from your purchase, read the instruction booklet before operating the unit. In the event that repair is necessary, or for the address nearest your location, please refer to the factory service center list below or within the Continental United States, Call 1-800-537-5722 for your authorized servicer. Remember to retain you Bill of Sale for Warranty Service.

—JVC

**JVC SERVICE & ENGINEERING
COMPANY OF AMERICA
DIVISION OF US JVC CORP.**

FACTORY SERVICE CENTER LOCATIONS

107 Little Falls Road
Fairfield, NJ 07004-2105
(201) 808-9279

1500 Lakes Parkway
Lawrenceville, GA 30243-5357
(770) 339-2522

705 Enterprise Street
Aurora, IL 60504-8149
(630) 851-7855

5665 Corporate Avenue
Cypress, CA 90630-0024
(714) 229-8011

2969 Mapunapuna Place
Honolulu, HI 96819-2040
(808) 833-5828

10700 Hammerly, Suite 110
Houston, TX 77043
(713) 935-9331

230 Eliot Street
Ashland, MA 0172-2377
(508) 881-5923

14505 Commerce Way
Miami Lakes, FL 33016-1512
(305) 362-6252

890 Dubuque Avenue
South San Francisco, CA 94080-1804
(415) 871-2666

Sophisticated electronic products may require occasional service. Just as quality is a keyword in the engineering and production of the wide array of JVC products, service is the key to maintaining the high level of performance for which JVC is world famous. The JVC service and engineering organization stands behind our products.

NATIONAL HEADQUARTERS
JVC SERVICE & ENGINEERING COMPANY OF AMERICA
DIVISION OF US JVC CORP.
107 Little Falls Road
Fairfield, NJ 07004-2105

If you ship the product •••

Pack your JVC unit in the original carton or one of equivalent size and strength. Enclose, with the unit, a letter stating the problem or symptom that exists and also a copy of the receipt or bill of sale you received when you purchased your JVC unit. Print your home return address on the outside and the inside of the carton. Send to the appropriate JVC Factory Service Center as listed above.

Don't service it yourself.

CAUTION

To prevent electrical shock, do not open the cabinet. No user serviceable parts inside.
Refer servicing to qualified service personnel.

ACCESSORIES

To purchase accessories for your JVC product, you may contact your local JVC Dealer. Or from the 48 Continental United States call toll free : 800-882-2345



LIMITED WARRANTY AUDIO-1

JVC COMPANY OF AMERICA warrants this product and all parts thereof, except as set forth below ONLY TO THE ORIGINAL PURCHASER AT RETAIL to be FREE FROM DEFECTIVE MATERIAL AND WORKMANSHIP from the date of original retail purchase for the period as shown below. ("The Warranty Period.")

PARTS	LABOR
1YR	1YR

THIS LIMITED WARRANTY IS VALID ONLY IN THE FIFTY(50) UNITED STATES, THE DISTRICT OF COLUMBIA AND IN COMMONWEALTH OF PUERTO RICO.

WHAT WE WILL DO:

If this product is found to be defective, JVC will repair or replace defective parts at no charge to the original owner. Such repair and replacement services shall be rendered by JVC during normal business hours at JVC authorized service centers. Parts used for replacement are warranted only for the remainder of the Warranty Period. All products and parts thereof may be brought to a JVC authorized service center on a carry-in basis except for Television sets having a screen size 25 inches and above which are covered on an in-home basis.

WHAT YOU MUST DO FOR WARRANTY SERVICE:

Return your product to a JVC authorized service center with a copy of your bill of sale. For your nearest JVC authorized service center, please call toll free: (800)537-5722. If service is not available locally, box the product carefully, preferably in the original carton, and ship, insured, with a copy of your bill of sale plus and letter of explanation of the problem to the nearest JVC Factory Service Center, the name and location of which will be given to you by the toll-free number. If you have any questions concerning your JVC Product, please contact our Customer Relations Department.

WHAT IS NOT COVERED:

This limited warranty provided by JVC does not cover:

1. Products which have been subject to abuse, accident, alteration, modification, tampering, negligence, misuse, faulty installation, lack of reasonable care, or if repaired or serviced by anyone other than a service facility authorized by JVC to render such service, or if affixed to any attachment not provided with the products, or if the model or serial number has been altered, tampered with, defaced or removed;
2. Initial installation and installation and removal for repair;
3. Operational adjustments covered in the Owner's Manual, normal maintenance, video and audio head cleaning;
4. Damage that occurs in shipment, due to act of God, and cosmetic damage;
5. Signal reception problems and failures due to line power surge;
6. Video Pick-up Tubes/CCD Image Sensor, Cartridge, Stylus(Needle) are covered for 90 days from the date of purchase;
7. Accessories;
8. Batteries (except the Rechargeable Batteries are covered for 90 days from the date of purchase);

There are no express warranties except as listed above.

THE DURATION OF ANY IMPLIED WARRANTIES, INCLUDING THE IMPLIED WARRANTY OF MERCHANTABILITY, IS LIMITED TO THE DURATION OF THE EXPRESS WARRANTY HEREIN.

JVC SHALL NOT BE LIABLE FOR THE LOSS OF USE THE PRODUCT, INCONVENIENCE, LOSS OR ANY OTHER DAMAGES, WHETHER DIRECT, INCIDENTAL OR CONSEQUENTIAL (INCLUDING, WITHOUT LIMITATION, DAMAGE TO TAPES, RECORDS OR DISCS) RESULTING FROM THE USE OF THIS PRODUCT, OR ARISING OUT OF ANY BREACH OF THIS WARRANTY. ALL EXPRESS AND IMPLIED WARRANTIES, INCLUDING THE WARRANTIES OF MERCHANTABILITY AND FITNESS FOR PARTICULAR PURPOSE, ARE LIMITED TO THE WARRANTY PERIOD SET FORTH ABOVE.

Some states do not allow the exclusion of incidental or consequential damages or limitations on how long an implied warranty last, so these limitations or exclusions may not apply to you. This warranty gives you specific legal rights and you may also have other rights which vary from state to state.

JVC COMPANY OF AMERICA
DIVISION OF US JVC CORP.

41 Slater Drive
Elmwood Park, New Jersey 07407

REFURBISHED PRODUCTS CARRY A SEPARATE WARRANTY, THIS WARRANTY DOES NOT APPLY. FOR DETAILS OF REFURBISHED PRODUCT WARRANTY, PLEASE REFER TO THE REFURBISHED PRODUCT WARRANTY INFORMATION PACKAGED WITH EACH REFURBISHED PRODUCT.

For customer use:

Enter below the Model No. and Serial No. which is located either on the rear, bottom or side of the cabinet. Retain this information for future reference.

Model No.: _____

Serial No.: _____

Purchase date: _____

Name of dealer: _____



JVC

VICTOR COMPANY OF JAPAN, LIMITED